



**SPECIFICATION
FOR
LCD Module
PV04303TD25E**

CUSTOMER	INITIAL	DATE
APPROVED BY		



REVISION STATUS

Version	Revise Date	Page	Content	Modified by
V1.0	2018.5.21	-	First Issued.	YANG



TABLE OF CONTENTS

- 1.General Description
- 2. Electrical Characteristics
- 3. Pin Description
- 4. Electrical Characteristics
- 5. Optical Characteristics
- 6. Quality Specifications
- 7. Reliability
- 8. Handling Precaution



1. General Description

* DESCRIPTION

PV04303TD25E is a color active matrix TFT (Thin Film Transistor) LCD (liquid crystal display) that uses amorphous silicon TFT as a switching device. This model is composed of a Transmissive type TFT-LCD Panel, driver circuit, back-light unit. The resolution of a 4.3" TFT-LCD contains 480 x 800 pixels, and can display up to 16.7M colors.

* Features

- Low Input Voltage: VCC: 2.5~3.6V; IOVCC: 1.65~3.6V
- Display Colors of TFT LCD: 16.7M colors
- CPU Interface: MIPI 2CH
- Internal Power Supply Circuit.

General Information Items	Specification	Unit	Note
	Main Panel		
Display area(AA)	56.16(H) *93.60(V) (4.3 inch)	mm	-
Driver element	a-Si TFT active matrix	-	-
Display colors	16.7M	colors	-
Number of pixels	480(RGB) *800	dots	-
Pixel arrangement	RGB vertical stripe	-	-
Pixel pitch	0.117(H) *0.117(V)	mm	-
Viewing angle	ALL	o'clock	-
Drive IC	ST7701S	-	-
Display mode	Normally Black	-	-
Operating temperature	-20~+70	°C	-
Storage temperature	-30~+80	°C	-

Mechanical Information

Item		Min.	Typ.	Max.	Unit	Note
Module size	Horizontal(H)	-	60.96	-	mm	±0.15
	Vertical(V)	-	104.50	-	mm	±0.2
	Depth(D)	-	1.74	-	mm	±0.15
Weight		-	23	-	g	-



2. MECHANICAL SPECIFICATION

A	B	C	D	7	6	5	4	3	2	1																																																		
<div style="display: flex; justify-content: space-between;"> <div style="width: 20%;"> <p>接口定义</p> <table border="1" style="width: 100%; border-collapse: collapse;"> <tr><td>1</td><td>LED+</td></tr> <tr><td>2</td><td>LED-</td></tr> <tr><td>3</td><td>GND</td></tr> <tr><td>4</td><td>TE</td></tr> <tr><td>5</td><td>NC</td></tr> <tr><td>6</td><td>IOVDD</td></tr> <tr><td>7</td><td>AVDD</td></tr> <tr><td>8</td><td>LEDPWM</td></tr> <tr><td>9</td><td>XRES</td></tr> <tr><td>10</td><td>NC</td></tr> <tr><td>11</td><td>NC</td></tr> <tr><td>12</td><td>GND</td></tr> <tr><td>13</td><td>NC</td></tr> <tr><td>14</td><td>NC</td></tr> <tr><td>15</td><td>GND</td></tr> <tr><td>16</td><td>DSL_D1P</td></tr> <tr><td>17</td><td>DSL_D1N</td></tr> <tr><td>18</td><td>GND</td></tr> <tr><td>19</td><td>DSL_CLKP</td></tr> <tr><td>20</td><td>DSL_CLKN</td></tr> <tr><td>21</td><td>GND</td></tr> <tr><td>22</td><td>DSL_D0P</td></tr> <tr><td>23</td><td>DSL_D0N</td></tr> <tr><td>24</td><td>GND</td></tr> <tr><td>25</td><td>GND</td></tr> </table> </div> <div style="width: 70%;"> <p style="text-align: right;">LED CIRCUIT DIAGRAM IF=20mA VF=25.2-30.6V</p> </div> </div>											1	LED+	2	LED-	3	GND	4	TE	5	NC	6	IOVDD	7	AVDD	8	LEDPWM	9	XRES	10	NC	11	NC	12	GND	13	NC	14	NC	15	GND	16	DSL_D1P	17	DSL_D1N	18	GND	19	DSL_CLKP	20	DSL_CLKN	21	GND	22	DSL_D0P	23	DSL_D0N	24	GND	25	GND
1	LED+																																																											
2	LED-																																																											
3	GND																																																											
4	TE																																																											
5	NC																																																											
6	IOVDD																																																											
7	AVDD																																																											
8	LEDPWM																																																											
9	XRES																																																											
10	NC																																																											
11	NC																																																											
12	GND																																																											
13	NC																																																											
14	NC																																																											
15	GND																																																											
16	DSL_D1P																																																											
17	DSL_D1N																																																											
18	GND																																																											
19	DSL_CLKP																																																											
20	DSL_CLKN																																																											
21	GND																																																											
22	DSL_D0P																																																											
23	DSL_D0N																																																											
24	GND																																																											
25	GND																																																											
<p>一. 产品特点 (Features):</p> <p>1. 产品规格: (Product specifications): 显示类型 (Display mode): TFT/Normal BLACK 驱动芯片 (Driver IC): ST1701S 人眼观察视角 (Viewing Direction): ALL 接口类型 (Interface Types): MIPI VIDEO MODE 背光类型 (Backlight Types): 9pins, 9灯串, 20mA (20mA/LED), 电压为25.2~30.6V 额定亮度 (LCD Brightness): 350 cd/m² Min, 400 cd/m² TYP 颜色坐标 (Color Coordinate): (X=0.29±0.03, Y=0.30±0.03) 模组均匀度 (LCM Uniformity): 80% MIN 操作温度 (Operating Temperature): -20°C ~ 70°C 储存温度 (Storage Temperature): -30°C ~ 80°C 平面翘曲度 (Plane Warping Degree): <math>\leq 0.3MM</math> 连接器 (PC CONN): FH26-25S-03SHW</p> <p>2. 一般公差: ±0.2mm. (GENERAL TOLERANCE: ±0.2)</p> <p>3. 尺寸中带有“*”为关键点尺寸。 (* Dimensions of the key control and Control Dimensions.)</p> <p>4. 图纸中带有“☞”特别说明及重点确认位置。 (Special Note And key Confirmation Position)</p> <p>5. 本产品符合 MIS 规定要求。 (All The Products Comply With The MIS Requirements).</p> <p>6. 可视区开窗设计要求: 建议外壳可视区域比模块VA单边小0.3mm以上。 (Visual Area Windows Design Requirements: The Proposed Shell Visual Area Than The Module VA Unilateral Small 0.3mm Above.).</p> <p>二. 防静电PCB A设计建议及要求: (The Antistatic PCB A Design Suggestions And Requests)</p> <p>1. 在RESET信号脚上接TVS管, 连接TVS管GND要补完整。 (TVS Tube Feet, Then The RESET Signal, Connect The TVS Tube GND To Shop Complete).</p> <p>2. 信号走线, 同时两侧包GND线。 (Signal Go Line, While Both Sides Of The Package GND Line).</p>																																																												
<table border="1" style="width: 100%; border-collapse: collapse;"> <tr> <td>标题 (Title):</td> <td colspan="2">Kingtech Group Co., Ltd.</td> </tr> <tr> <td>规格 (Ver):</td> <td colspan="2">LCM</td> </tr> <tr> <td>比例 (Scale):</td> <td>比例 (Scale):</td> <td>1:1</td> </tr> <tr> <td>单位 (Unit):</td> <td>单位 (Unit):</td> <td>1/1</td> </tr> <tr> <td>日期 (Date):</td> <td>日期 (Date):</td> <td>2018.05.17</td> </tr> <tr> <td>版本号 (Version):</td> <td>版本号 (Version):</td> <td></td> </tr> <tr> <td>设计 (DESIGN):</td> <td>设计 (DESIGN):</td> <td></td> </tr> <tr> <td>审核 (CHECKING):</td> <td>审核 (CHECKING):</td> <td></td> </tr> <tr> <td>批准 (APPROVE):</td> <td>批准 (APPROVE):</td> <td></td> </tr> <tr> <td>产品型号 (Product Type):</td> <td colspan="2">PV04303TD25E</td> </tr> <tr> <td>变更记录 (Change History):</td> <td colspan="2"></td> </tr> </table>											标题 (Title):	Kingtech Group Co., Ltd.		规格 (Ver):	LCM		比例 (Scale):	比例 (Scale):	1:1	单位 (Unit):	单位 (Unit):	1/1	日期 (Date):	日期 (Date):	2018.05.17	版本号 (Version):	版本号 (Version):		设计 (DESIGN):	设计 (DESIGN):		审核 (CHECKING):	审核 (CHECKING):		批准 (APPROVE):	批准 (APPROVE):		产品型号 (Product Type):	PV04303TD25E		变更记录 (Change History):																			
标题 (Title):	Kingtech Group Co., Ltd.																																																											
规格 (Ver):	LCM																																																											
比例 (Scale):	比例 (Scale):	1:1																																																										
单位 (Unit):	单位 (Unit):	1/1																																																										
日期 (Date):	日期 (Date):	2018.05.17																																																										
版本号 (Version):	版本号 (Version):																																																											
设计 (DESIGN):	设计 (DESIGN):																																																											
审核 (CHECKING):	审核 (CHECKING):																																																											
批准 (APPROVE):	批准 (APPROVE):																																																											
产品型号 (Product Type):	PV04303TD25E																																																											
变更记录 (Change History):																																																												



3. PIN DESCRIPTION

Pin NO.	Symbol	Level	Function
1	LEDA	H	Backlight+
2	LEDK	L	Backlight-
3	GND	L	Ground
4	TE	H/L	Tearing effect output
5	NC	/	Not Connect
6	IOVCC	H	Power supply
7	VCC	H	Power supply
8	LEDPWM		LCD Backlight Control PWM Signal
9	RESET	H/L	Hardware reset pin
10-11	NC	/	Not Connect
12	GND	L	Ground
13-14	NC	/	Not Connect
15	GND	L	Ground
16	D1P	H/L	HSSI_D1+ are differential data signal line.
17	D1N	H/L	HSSI_D1- are differential data signal line.
18	GND	L	Ground
19	CLKP	H/L	HSSI_CLK+ are differential data signal line.
20	CLKN	H/L	HSSI_CLK- are differential data signal line.
21	GND	L	Ground
22	D0P	H/L	HSSI_D0+ are differential data signal line.
23	D0N	H/L	HSSI_D0- are differential data signal line.
24-25	GND	L	Ground



4. ELECTRICAL CHARACTERISTICS

4.1 ABSOLUTE MAXIMUM RATINGS

Item	Symbol	Values		Unit	Remark
		Min	Max.		
Supply Voltage for Logic circuit	VDDIO	1.65	3.6	V	
Supply Voltage for analog circuit	VCC	2.5	3.6	V	

4.2 DC ELECTRICAL CHARACTERISTICS

4.2.1 OPERATING CONDITIONS

Typical Operating Conditions (Ta=25°C)

Item	Symbol	Values			Unit	Remark
		Min	Typ	Max.		
Power Supply	VCC	2.5	-	3.6	V	
Power Supply	VDDIO	1.65	1.8	3.6	V	
Normal mode Current consumption	I _{CC}	-	45	55	mA	V _{CC} =2.8V
TFT Gate ON Voltage	V _{GH}	10	-	18	V	
TFT Gate OFF Voltage	V _{GL}	-15	-	-10	V	

4.2.2 BACKLIGHT UNIT (GND=0V)

Item	Symbol	Values			Unit	Remark
		Min	Typ	Max.		
Forward supply Voltage	V _f	25.2	-	30.6	V	
Forward supply Current	I _f	-	20	-	mA	
LCM Luminance	L _V	350	400	-	cd/m ²	I _B =20mA
Uniformity	/	80			%	-



4.3.1 TIMING CHARACTERISTICS

High Speed Mode

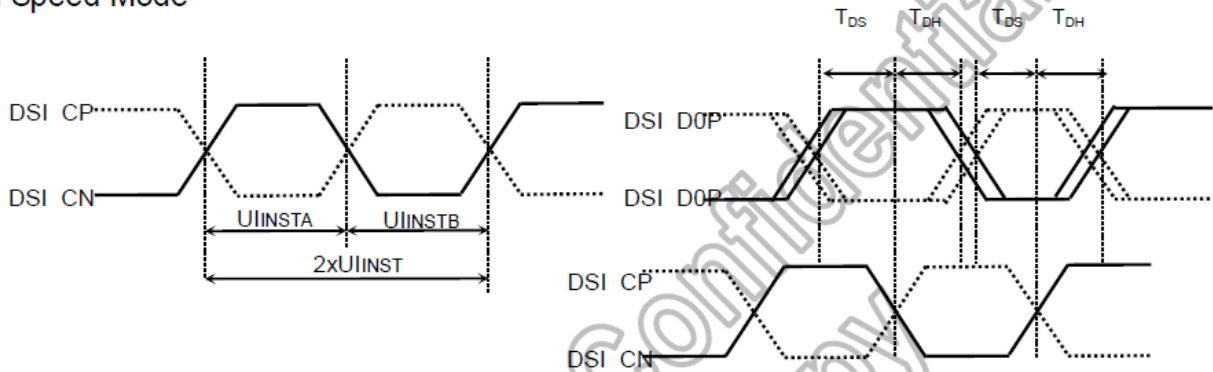

DSI clock Timing Characteristics

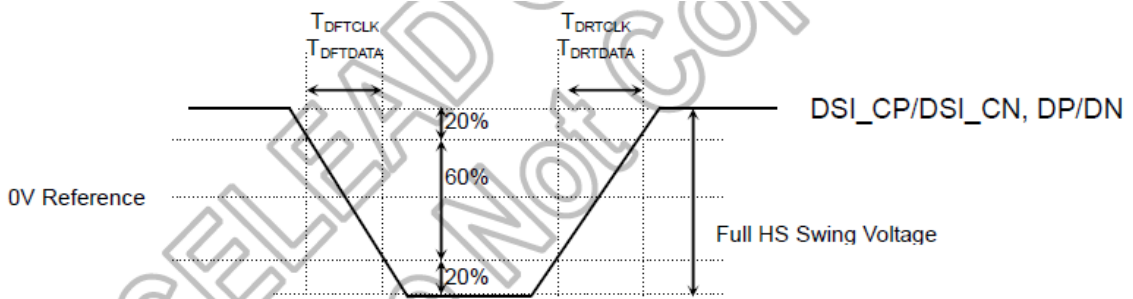

Rising and falling time on clock and data channel

(VSSA=0V, IOVCC=1.65V to 3.3V, VCI=2.5V to 3.3V, TA = -30 to 70°C)

Signal	Item	Symbol	Spec.			Unit
			Min.	Typ.	Max.	
DSI_CP/ DSI_CN	Double UI instantaneous	2xUIINST	TBD	-	25	ns
	UI instantaneous	UIINSTA UIINSTB	TBD	-	12.5	ns
DP/DN	Data to clock setup time	T _{DS}	0.15xUI	-	-	ps
	Data to clock hold time	T _{DH}	0.15xUI	-	-	ps
DSI_CP/ DSI_CN	Differential rise time for clock	T _{DFTCLK}	150	-	0.3UI	ps
	Differential fall time for clock	T _{DFTCLK}	150	-	0.3UI	ps
DP/DN	Differential rise time for data	T _{DRTDATA}	150	-	0.3UI	ps
	Differential fall time for data	T _{DFTDATA}	150	-	0.3UI	ps

DSI High Speed Mode characteristics

Low Power Mode

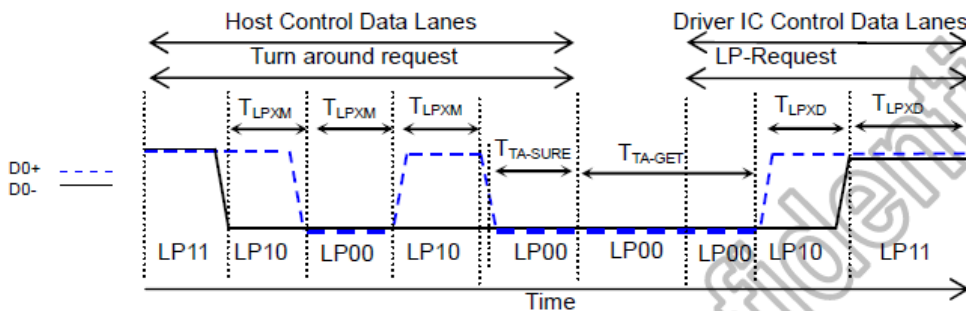

BTA from HOST to Display module Timing

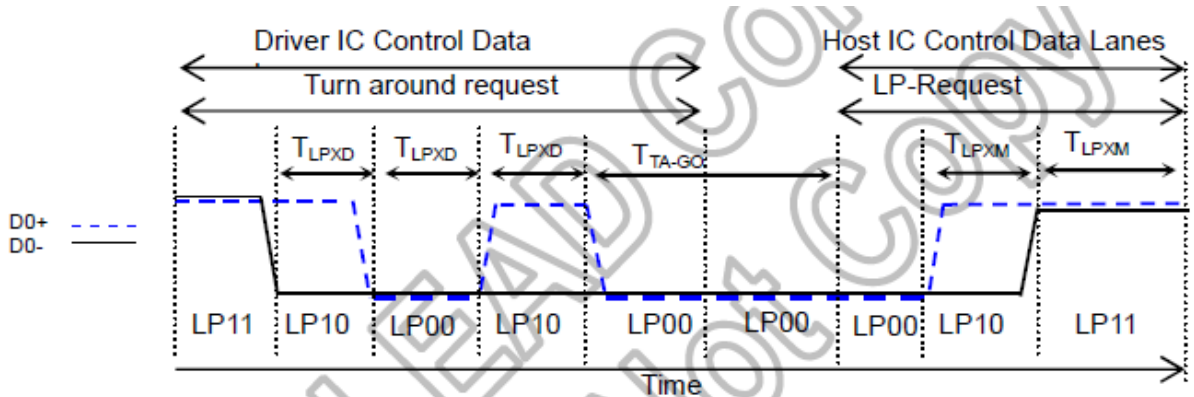

BTA from Display module Timing to HOST

(VSSA=0V, IOVCC=1.65V to 3.3V, VCI=2.3V to 3.3V, T_A = -30 to 70°C)

Signal	Item	Symbol	Spec.			Unit
			Min.	Typ.	Max.	
DSI_D0P/ DSI_D0P	Length of LP-00/LP01/LP10/LP11 Host → Display module	T _{LPXM}	50	-	-	ns
	Length of LP-00/LP01/LP10/LP11 Display module → Host	T _{LPXD}	50	-	-	ns
	Time-out before the MPU start driver	T _{TA-SURE}	T _{LPXD}	-	2xT _{LPXD}	ns
	Time to drive LP-00 by display module	T _{TA-GET}	5xT _{LPXD}	-	-	ns
	Time to drive LP-00 after turnaround request Host	T _{TAGO}	4xT _{LPXD}	-	-	ns

DSI Low Power Mode characteristics

DSI BURSTS

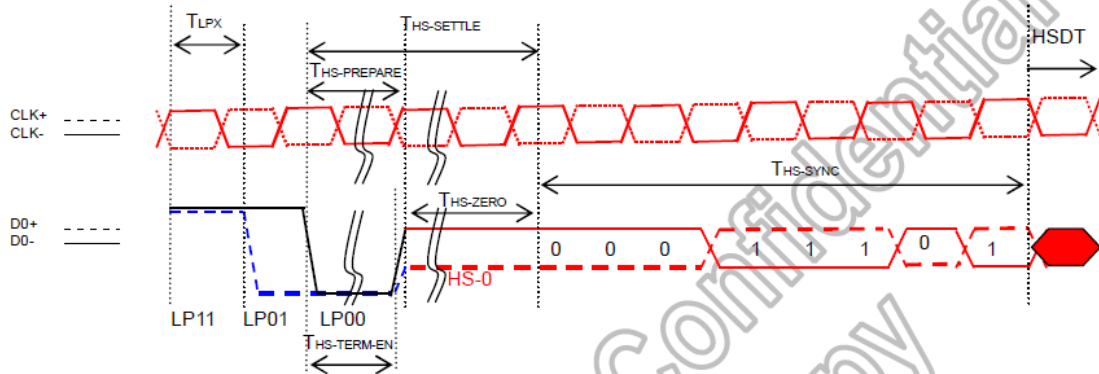

Signal	Item	Symbol	Spec.			Unit
			Min.	Typ.	Max.	
DSI_D0P/ DSI_D0P	Length of LP-00/LP01/LP10/LP11	T _{LPX}	50	-	-	ns
	Time to Driver LP-00 to prepare for HS transmission	T _{HS-PREPARE}	40+4UI	-	85+6UI	ns
	Time to enable data receiver line termination	T _{HS-TERM-EN}	-	-	35+4xUI	ns
	Time to drive LP-00 by display module	T _{TA-GET}	5xT _{LPXD}	-	-	ns
	Time to drive LP-00 after turnaround request Host	T _{TAGO}	4xT _{LPXD}	-	-	ns

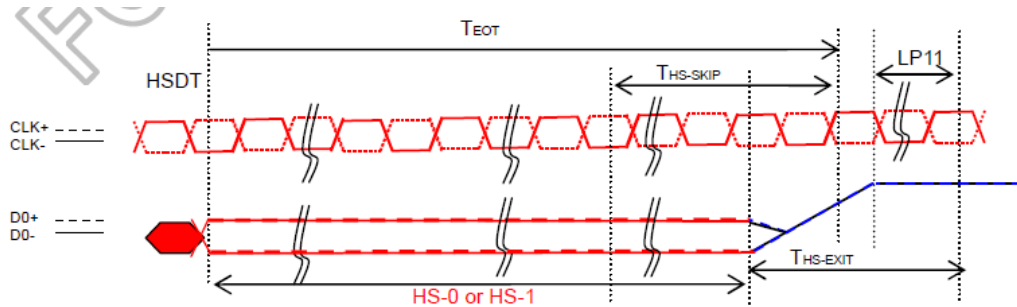

NOTE:
 If the last bit is HS-0, the transmitter changes from HS-0 to HS-1
 If the last bit is HS-0, the transmitter changes from HS-1 to HS-0

Signal	Item	Symbol	Spec.			Unit
			Min.	Typ.	Max.	
DSI_D0P/ DSI_D0P	Time-Out at Display Module to Ignore Transition Period of EoT	T _{HS-SKIP}	40	-	55+4xUI	ns
	Time to Driver LP-11 after HS Burst	T _{HS-EXIT}	100	-	-	ns

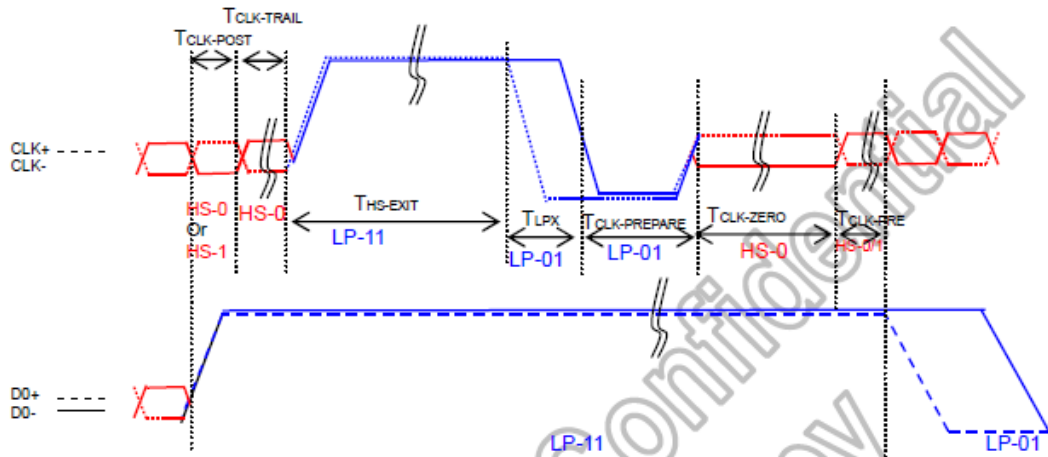

Signal	Item	Symbol	Spec.			Unit
			Min.	Typ.	Max.	
DSI_CP/ DSI_CN	Time that the MCU shall continue sending HS clock after the last associated Data Lane has transitioned to LP mode	T _{CLK-POST}	60+52xUI	-	-	ns
	Time to drive HS differential state after last payload clock bit of a HS transmission burst	T _{CLK-TRAIL}	60	-	-	ns
	Time to drive LP-11 after HS burst	T _{HS-EXIT}	100	-	-	ns
	Time to drive LP-00 to prepare for HS transmission	T _{CLK-PREPARE}	38	-	95	ns
	Time-out at Clock Lane Display Module to enable HS Termination	T _{CLK-TERM-EN}	-	-	38	ns
	Minimum lead HS-0 drive period before starting Clock	T _{CLK-PREPARE} + T _{CLK-ZERO}	300	-	-	ns
	Time that the HS clock shall be driven prior to any associated data Lane beginning the transition from LP to HS mode	T _{CLK-PRE}	8xUI			



4.3.2. Reset input timing

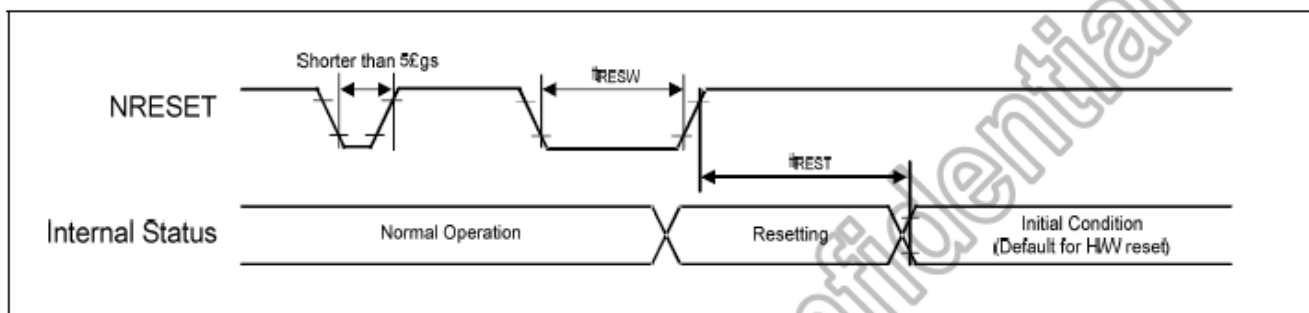

Symbol	Parameter	Related Pins	Spec.			Note	Unit
			Min.	Typ.	Max.		
tRESW	Reset low pulse width ⁽¹⁾	NRESET	10	-	-	-	µs
tREST	Reset complete time ⁽²⁾	-	5	-	-	When reset applied during SLPIN mode	ms
		-	120	-	-	When reset applied during SLPOUT mode	ms

Note: (1) Spike due to an electrostatic discharge on NRESET line does not cause irregular system reset according to the following table.

NRESET Pulse	Action
Shorter than 5 µs	Reset Rejected
Longer than 10 µs	Reset
Between 5 µs and 10 µs	Reset Start

- (2) During the resetting period, the display will be blanked (The display is entering blanking sequence, which Maximum time is 120 ms, when Reset Starts in Sleep Out –mode. The display remains the blank state in Sleep In –mode) and then return to Default condition for H/W reset.
- (3) During Reset Complete Time, ID and VCOM value in OTP will be latched to internal register during this period. This loading is done every time when there is H/W reset complete time (tREST) within 5ms after a rising edge of NRESET.
- (4) Spike Rejection also applies during a valid reset pulse as shown as below:

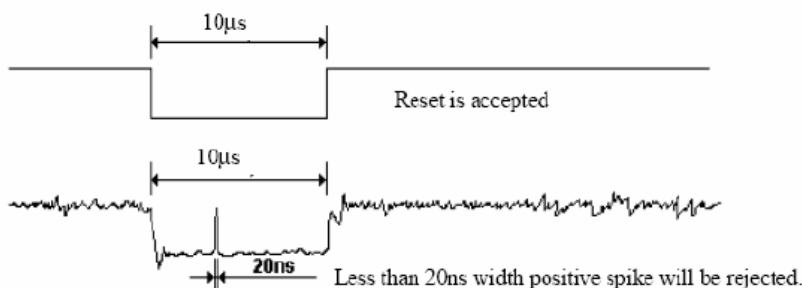

- (5) It is necessary to wait 5msec after releasing NRESET before sending commands. Also Sleep Out command cannot be sent for 120msec.



5. OPTICAL CHARACTERISTICS

The test of Optical specifications shall be measured in a dark room (ambient luminance ≤ 1 lux and temperature = $25 \pm 2^\circ\text{C}$) with the equipment of Luminance meter system (Goniometer system and TOPCON BM-5) and test unit shall be located at an approximate distance 50cm from the LCD surface at a viewing angle of θ and Φ equal to 0° . The center of the measuring spot on the Display surface shall stay fixed.

The backlight should be operating for 30 minutes prior to measurement.

<Table 4. Optical Specifications>

Item	Symbol	Condition	Min.	Typ.	Max.	Unit
Viewing Angle	θ_L	C.R. ≥ 10	70	80	-	degree
	θ_R		70	80	-	
	θ_U		70	80	-	
	θ_D		70	80	-	
Contrast Ratio	-	T = 25°C	650	800	-	-
Transmittance	T%(with polarizer+ D65 light)	T = 25°C	4.1	4.3	-	%
Response time	Tr	T = 25°C	35		40	ms
	Tf					

MDL Chromaticity Specification (CIE 1931)

Item	Symbol	Condition	Min.	Typ.	Max.
Red Color	Ru'	T= 25°C (CF、C light)	0.603	0.623	0.643
	Rv'		0.321	0.341	0.361
Green Color	Gu'		0.305	0.325	0.345
	Gv'		0.600	0.620	0.640
Blue Color	Bu'		0.130	0.150	0.170
	Bv'		0.036	0.056	0.076
White Color	Wu'		0.275	0.295	0.315
	Wv'		0.302	0.322	0.342
Black Color	Ku'		-	-	-
	Kv'		-	-	-
NTSC	%		73.5%	68.5%	-

CF Chromaticity Specification (CIE 1931)

Item	Symbol	Condition	Min.	Typ.	Max.
Red Color	Rx	T=25°C (CF、C light)	0.625	0.645	0.665
	Ry		0.302	0.322	0.342
Green Color	Gx		0.257	0.277	0.297
	Gy		0.572	0.592	0.612
Blue Color	Bx		0.115	0.135	0.155
	By		0.078	0.098	0.118
White Color	Wx		0.280	0.300	0.320
	Wy		0.313	0.333	0.353
Black Color	Wx		-	-	-
	Wy		-	-	-
NTSC	%		64.7%	69.7%	74.7%

NOTE : (1).Base on Normal Polarizer: Viewing angle、Contrast ratio、Response time. (The front and rear polarizer need to cross.)



6. QUALITY SPECIFICATIONS

6.1 INSPECTION CONDITION

- (1) Inspect under 300~500Lux fluorescent light, leaving 30~35cm between panels and eyes, and between panels and lights.
- (2) Inspection condition is $23\pm 5^{\circ}\text{C}$, $50\pm 20\%RH$ maximum.

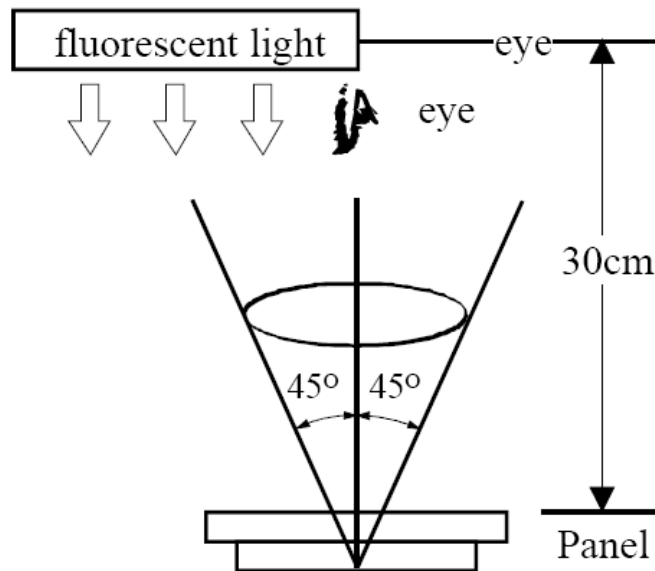

6.2 DEFINITION OF AREA

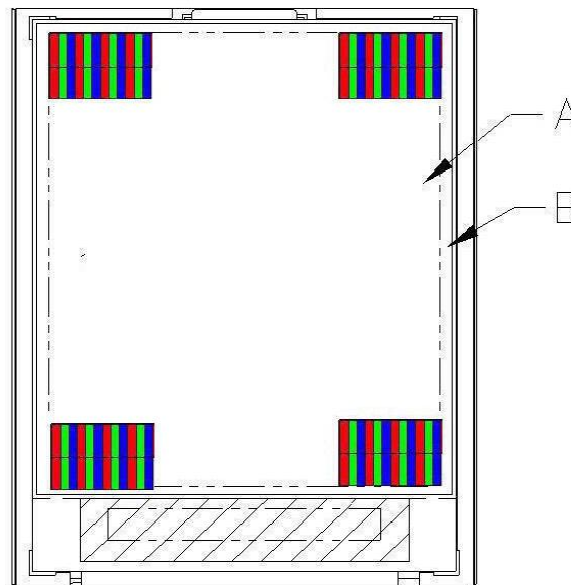

A Area : Viewing area.

B Area : Out of viewing. (outside viewing area)

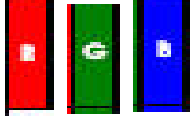
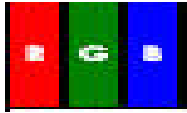

6.3 INSPECTION SPECIFICATION

NO	Item	Acceptable specification	Judgment Criterion
1	Electrical Testing	<p>1-1 sub pixel classification</p> <ul style="list-style-type: none"> ● Sub Pixel: Number of sub pixel doesn't exceed one dot. <div style="text-align: center;">  <p>Sub Pixel (Dot)</p> </div> <p>a> Dark dot ----one Allowed b> Bright dot ---- one Allowed</p> <ul style="list-style-type: none"> ● Pixel : Three dots link together doesn't exceed ones <div style="text-align: center;">  <p>Pixel</p> </div> <p>1-2 Leakage to light</p> <ul style="list-style-type: none"> ● Leakage to light be not allowed. <p>1-3 Picture to shake</p> <ul style="list-style-type: none"> ● Picture had shake, twinkle and noise etc. instable of defect that be not allowed. <p>1-4 Function</p> <ul style="list-style-type: none"> ● No display or No function. ● Source Line, Gate Line. ● Contrast Ratio ● Current consumption exceeds product specifications. ● Display malfunction. 	<p>N ≦ 2</p> <p>N ≦ 0</p> <p>N=0</p> <p>N=0</p> <p>N=0</p>
2	Mechanical Dimension	<p>2-1 Mechanical Dimension exceeds product specifications.</p> <p>2-2 Out of frame and boss of plastic changed shape that be not allowed.</p>	N=0

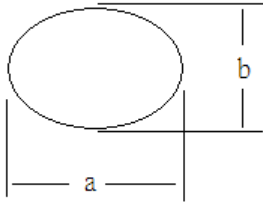

NO	Item	Acceptable specification	Judgment Criterion																																												
3	Cosmetic Inspection	<p>3-1 Blemish: Line shapes of defect</p> <table border="1" data-bbox="363 405 1313 757"> <thead> <tr> <th>Length</th> <th>Width</th> <th>Acceptable number</th> <th>Mini. space</th> </tr> </thead> <tbody> <tr> <td>---</td> <td>$W \leq 0.05$</td> <td>Ignore</td> <td rowspan="3">5 m m</td> </tr> <tr> <td>$L \leq 3.0$</td> <td>$0.05 < W \leq 0.08$</td> <td>4</td> </tr> <tr> <td>$L \leq 3.0$</td> <td>$0.08 < W \leq 0.15$</td> <td>3</td> </tr> <tr> <td>--</td> <td>$W > 0.15$</td> <td>Not allowed</td> <td>---</td> </tr> </tbody> </table> <p>L: length(mm) W: width(mm)</p>  <p>3-2 Blemish: dot shapes of defect.</p> <table border="1" data-bbox="435 1014 1281 1249"> <thead> <tr> <th>Dimension</th> <th>Acceptable number</th> <th>Mini. Space</th> </tr> </thead> <tbody> <tr> <td>$\Phi \leq 0.15$</td> <td>Ignore</td> <td>---</td> </tr> <tr> <td>$0.15 < \Phi \leq 0.20$</td> <td>3</td> <td rowspan="2">5 m m</td> </tr> <tr> <td>$0.20 < \Phi \leq 0.30$</td> <td>2</td> </tr> <tr> <td>$\Phi > 0.30$</td> <td>1</td> <td>---</td> </tr> </tbody> </table> <p>3-3 Polarizer Bubble</p> <table border="1" data-bbox="435 1323 1281 1480"> <thead> <tr> <th>Dimension</th> <th>Acceptable number</th> <th>Mini. Space</th> </tr> </thead> <tbody> <tr> <td>$\Phi \leq 0.25$</td> <td>Ignore</td> <td>---</td> </tr> <tr> <td>$0.25 < \Phi \leq 0.35$</td> <td>3</td> <td>15 m m</td> </tr> <tr> <td>$\Phi > 0.35$</td> <td>1</td> <td>---</td> </tr> </tbody> </table> <p>Foreign Substances</p>  <p>$\Phi = (a+b)/2$</p>	Length	Width	Acceptable number	Mini. space	---	$W \leq 0.05$	Ignore	5 m m	$L \leq 3.0$	$0.05 < W \leq 0.08$	4	$L \leq 3.0$	$0.08 < W \leq 0.15$	3	--	$W > 0.15$	Not allowed	---	Dimension	Acceptable number	Mini. Space	$\Phi \leq 0.15$	Ignore	---	$0.15 < \Phi \leq 0.20$	3	5 m m	$0.20 < \Phi \leq 0.30$	2	$\Phi > 0.30$	1	---	Dimension	Acceptable number	Mini. Space	$\Phi \leq 0.25$	Ignore	---	$0.25 < \Phi \leq 0.35$	3	15 m m	$\Phi > 0.35$	1	---	
		Length	Width	Acceptable number	Mini. space																																										
		---	$W \leq 0.05$	Ignore	5 m m																																										
		$L \leq 3.0$	$0.05 < W \leq 0.08$	4																																											
		$L \leq 3.0$	$0.08 < W \leq 0.15$	3																																											
		--	$W > 0.15$	Not allowed	---																																										
		Dimension	Acceptable number	Mini. Space																																											
		$\Phi \leq 0.15$	Ignore	---																																											
		$0.15 < \Phi \leq 0.20$	3	5 m m																																											
		$0.20 < \Phi \leq 0.30$	2																																												
$\Phi > 0.30$	1	---																																													
Dimension	Acceptable number	Mini. Space																																													
$\Phi \leq 0.25$	Ignore	---																																													
$0.25 < \Phi \leq 0.35$	3	15 m m																																													
$\Phi > 0.35$	1	---																																													



NO	Item	Acceptable specification				Judgment Criterion
3	Cosmetic Inspection	3-4 Scratch ● Sensate scratch not allowed. ● Impassive scratch as below. <div style="text-align: right; color: red;">Unit:mm</div>				
		Length	Width	Acceptable number	Mini. space	
		-----	$W \leq 0.05$	Ignore	5 m m	
		$L \leq 3.0$	$0.05 < W \leq 0.08$	4		
		$L \leq 3.0$	$0.08 < W \leq 0.15$	3	---	
		----	$0.15 < W$	Not allowed		
		$L > 3.0$	----	Not allowed		
		4	Package	4-1 Mixed product types 4-2 Shipping q'ty should be the same as "shipping notice form" q'ty. 4-3 Outer box can't broken.		



7. RELIABILITY

Test Item	Test Condition
High Temperature Operation	70°C for 96 hours
Low Temperature Operation	-20°C for 96 hours
High Temperature Storage	80°C for 96 hours
Low Temperature Storage	-30°C for 96 hours
High Temperature Operation Humidity Operation	60°C, 90%RH for 72 hours
Thermal Shock	-10°C (30min) ~+25°C (5min)~ +60°C (30min) for 10 cycles
Vibration Test (No Operation)	Frequency: 10~55Hz Amplitude:1.0mm Sweep Time: 11min Test Period: 6 Cycles for each direction of X, Y, Z
Static electricity test	Touch 4KV,air touch 8KV



8. HANDLING PRECAUTION

8.1 SAFETY

- (1) Do not swallow any liquid crystal, even if there is no proof that liquid crystal is poisonous.
- (2) If the LCD panel breaks, be careful not to get liquid crystal to touch your skin.
- (3) If skin is exposed to liquid crystal, wash the area thoroughly with alcohol or soap.

8.2 STORAGE CONDITIONS

- (1) Store the panel or module in a dark place where the temperature is $23\pm 5^{\circ}\text{C}$ and the humidity is below $50\pm 20\% \text{RH}$.
- (2) Store in anti-static electricity container.
- (3) Store in clean environment, free from dust, active gas, and solvent.
- (4) Do not place the module near organics solvents or corrosive gases.
- (5) Do not crush, shake, or jolt the module.

8.3 HANDLING PRECAUTIONS

- (1) Avoid static electricity which can damage the CMOS LSI.
- (2) The polarizing plate of the display is very fragile. So, please handle it very carefully.
- (3) Do not give external shock.
- (4) Do not apply excessive force on the surface.
- (5) Do not wipe the polarizing plate with a dry cloth, as it may easily scratch the surface of plate.
- (6) Do not use ketonic solvent & Aromatic solvent, use with a soft cloth soaked with a cleaning naphtha solvent.
- (7) Do not operate it above the absolute maximum rating.
- (8) Do not remove the panel or frame from the module.

8.4 WARRANTY

- 1) The period is within twelve months since the date of shipping out under normal using and storage conditions.
- 2) According to Kingtech TFT LCD quality standard, Kingtech will rework or exchange for functional defect goods since within one year.