





- Tentative Specification
- Preliminary Specification
- Approval Specification

SPECIFICATION

Product Model: PV07063Y0150Q

From: Kingtech Group Co.,Ltd.

DESIGNED	CHECKED	Approved
		

For Customer's Acceptance:

Comments:	Approved by:
------------------	---------------------



Table of Contents

List	Description	Page No.
	Cover	1
	Revision Record	2
	Table of Contents	3
1	Scope	4
2	General Information	4
3	External Dimensions	5
4	Interface Description	6
5	Electrical specification	7
6	Absolute Maximum Ratings	8
7	Timing Characteristics	9
8	Backlight Characteristics	13
9	Optical Characteristics	14
10	Reliability Test Conditions and Methods	16
11	Inspection Standard	17
12	Handling Precautions	21
13	Precaution for Use	22
14	Packing Method	22



1. Scope

This specification defines general provisions as well as inspection standards for TFT module supplied by Kingtech Group Co.,Ltd.

If the event of unforeseen problem or unspecified items may occur, naturally shall negotiate and agree to solution.

2. General Information

TITEM	STANDARD VALUES	UNITS
LCD type	7.0”TFT	--
Dot arrangement	1024(RGB)×600	dots
Color filter array	RGB vertical stripe	--
Display mode	Normally Black , Transmissive	-
Gray Scale Inversion Direction	ALL	--
Eyes Viewing Direction	85/85/85/85	
Module size	164.80(W)×100.00(H)×2.8(T)	mm
Active area	154.21(W)×85.92(H)	mm
Dot pitch	0.1506(W)×0.1432(H)	mm
Interface	TTL	--
Operating temperature	-20 ~ +70	°C
Storage temperature	-30 ~ +80	°C
Back Light	24White LED	--
Weight	TBD	g



3. External Dimensions

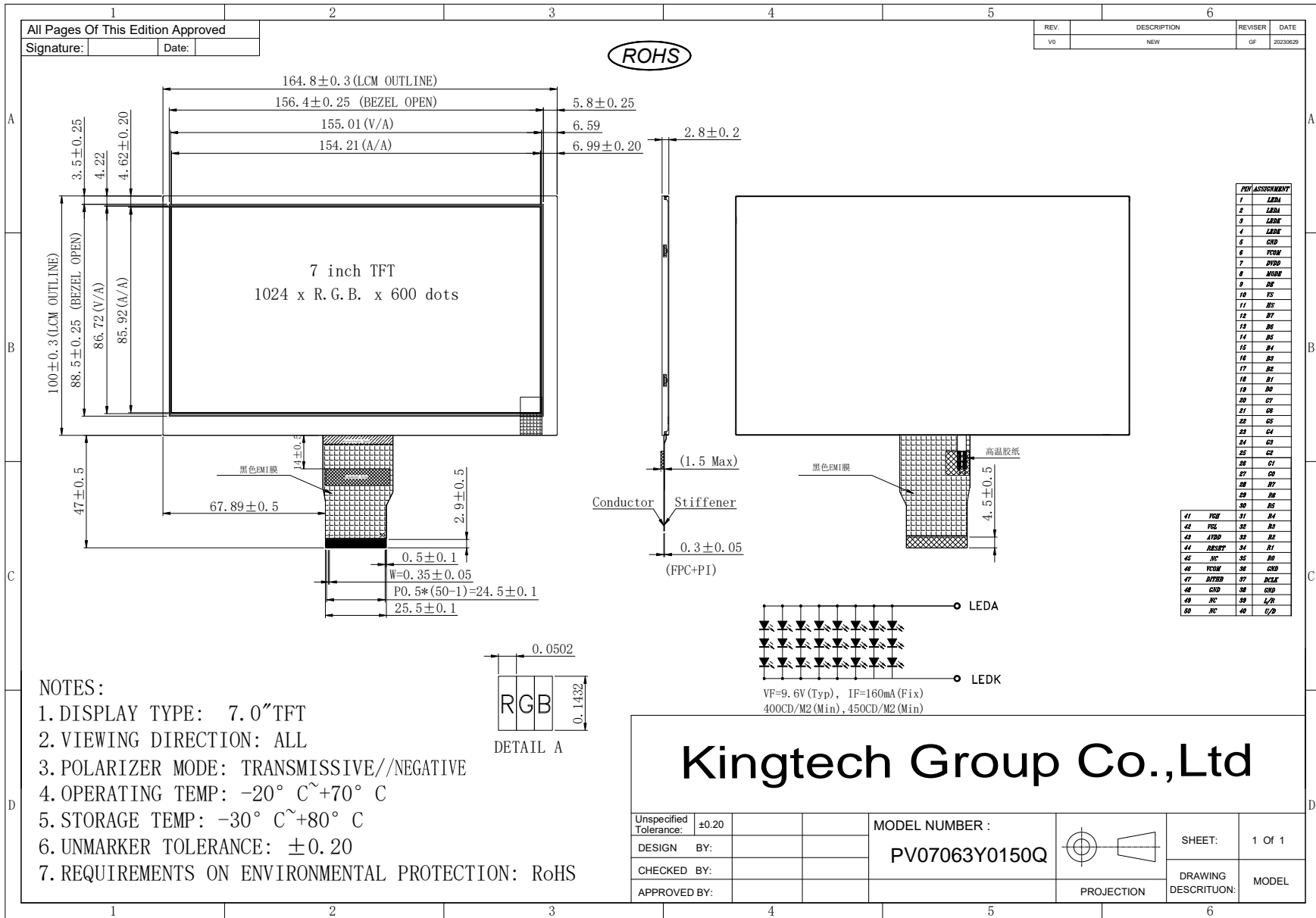



4. Interface Description

PIN	PIN NAME	DESCRIPTION
1	LEDA	LED backlight (Anode).
2	LEDA	
3	LEDK	LED backlight (Cathode).
4	LEDK	
5	GND	Power ground
6	VCOM	Common Voltage.
7	DVDD	Digital Power.
8	MODE	DE/SYNC mode select. Normally pull high. H: DE mode. L: HSD/VSD mode.
9	DE	Data Enable signal.
10	VS	Vertical sync input. Negative polarity.
11	HS	Horizontal sync input. Negative polarity.
12	B7	Blue Data Input (MSB).
13	B6	Blue Data Input.
14	B5	Blue Data Input.
15	B4	Blue Data Input.
16	B3	Blue Data Input.
17	B2	Blue Data Input.
18	B1	Blue Data Input.
19	B0	Blue Data Input (LSB).
20	G7	Green Data Input (MSB).
21	G6	Green Data Input.
22	G5	Green Data Input.
23	G4	Green Data Input.
24	G3	Green Data Input.
25	G2	Green Data Input.
26	G1	Green Data Input.
27	G0	Green Data Input (LSB).
28	R7	Red Data Input (MSB).
29	R6	Red Data Input.
30	R5	Red Data Input.
31	R4	Red Data Input.
32	R3	Red Data Input.
33	R2	Red Data Input.
34	R1	Red Data Input.
35	R0	Red Data Input (LSB).
36	GND	Power ground.
37	DCLK	Clock input.
38	GND	Power ground.



39	L/R	Left or Right Display Control.
40	U/D	Up / Down Display Control.
41	VGH	Positive Power for TFT.
42	VGL	Negative Power for TFT.
43	AVDD	Analog Power.
44	RESET	Global reset pin. Active low to enter reset state. Suggest to connecting with an RC reset circuit for stability. Normally pull high.(R=10KΩ, C=1μF)
45	NC.	Not connect.
46	VCOM	Common Voltage.
47	DITHB	Dithering function enable control. (Normally pull high) DITHB="L", to enable internal dithering function. DITHB="H", to disable internal dithering function.
48	GND	Power ground.
49	NC.	Not connect.
50	NC.	Not connect.

**Note 1: SHLR: left or right setting
UPDN: up or down setting**

UPDN	SHLR	FUNCTION
DVDD	GND	Left → Right , Up → Down(default)
GND	GND	Right→Left, Up→Down
DVDD	DVDD	Left→Right, Down→Up
GND	DVDD	Right→Left, Down→Up

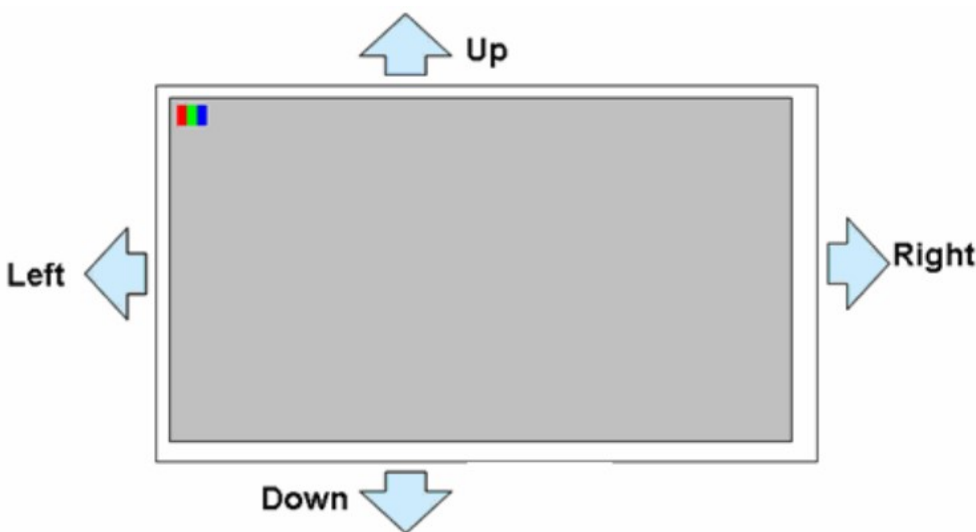



5. Electrical specification

Item	Symbol	Min.	Typ.	Max.	Unit	Remark
Input signal Voltage	VCOM	3.0	3.68	8.0	V	-
Logic Supply Voltage	DVDD	2.3	3.3	3.6	V	-
Analog Supply Voltage	AVDD	8.9	9.7	10.5	V	
Low Supply Voltage	VGL	-7.1	-6.0	-5.5	V	
High Supply Voltage	VGH	16	18	19	V	
Output High Voltage	VIH	0.7XVDD	-	VDD	V	-
Output Low Voltage	VIL	0	-	0.3xVDD	V	-

Note 1: Please adjust VCOM to make the flicker level be minimum. Typ VCOM 电压值
只做参考, 具体以实际效果为准 (根据FLICKER 状态可调整)

Note 2: The gate IC is the EK73215BCGA, The source IC is theEK79001

6. Absolute Maximum Ratings

Item	Symbol	Min.	Max.	Unit
Logic Supply Voltage	DVDD	-0.5	5	V
Analog Supply Voltage	AVDD	-0.5	15	V
High Supply Voltage	VGH	-0.3	40	V
Low Supply Voltage	VGL	-20	0.3	V
Operating Temperature	TOP	-20	70	°C
Storage Temperature	TST	-30	80	°C



7. Timing Characteristics

7.1 Vertical Input timing

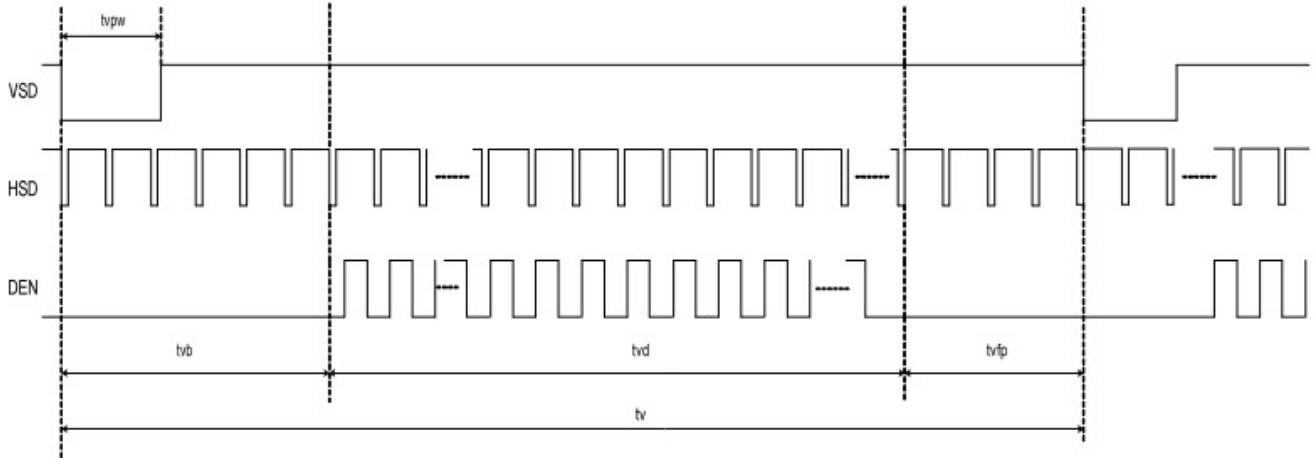

7.2 Horizontal input timing

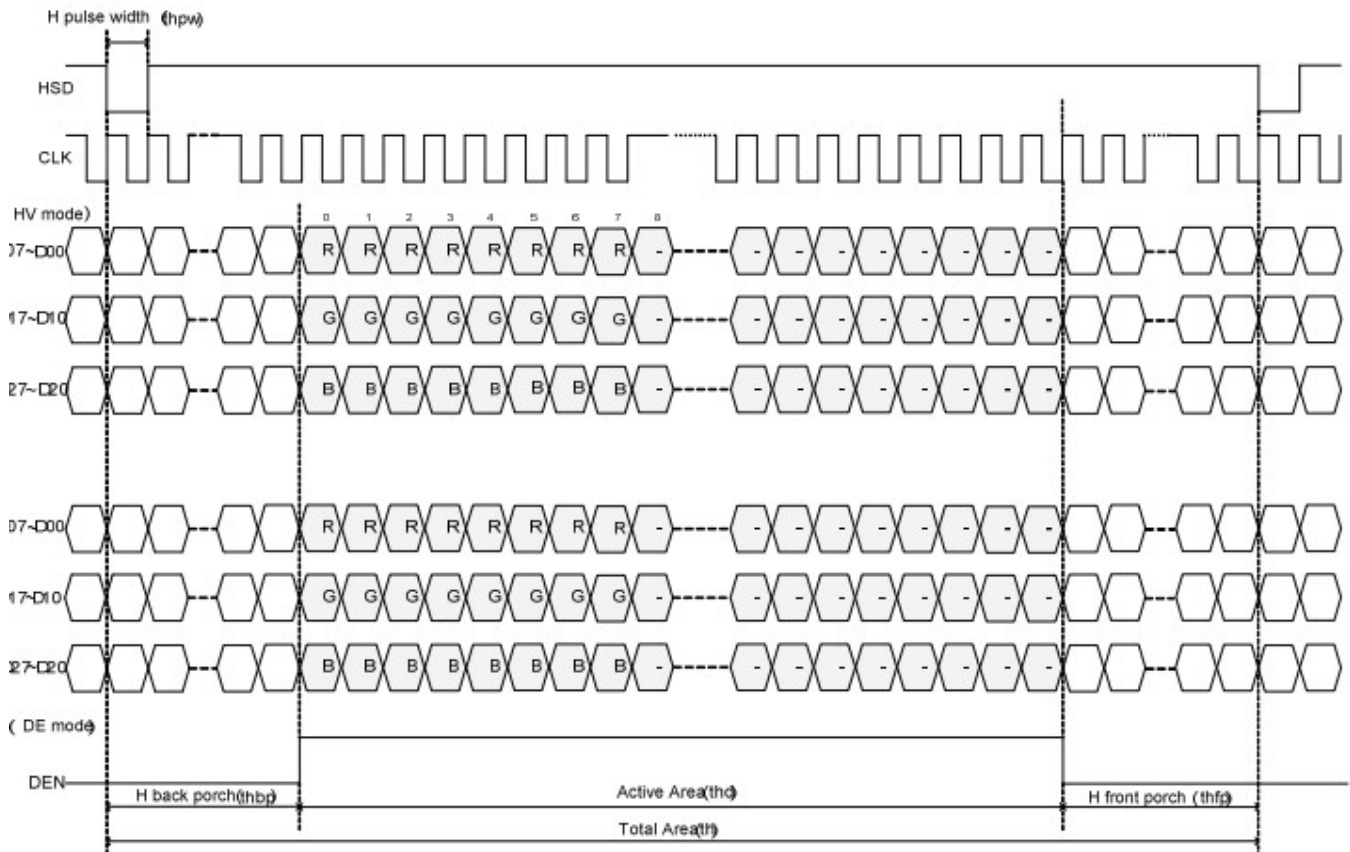

Horizontal input timing



7.3 DE mode

DE mode					
Parameter	Symbol	Value			Unit
		Min.	Typ.	Max.	
DCLK frequency @Frame rate=60hz	fclk	40.8	51.2	67.2	Mhz
Horizontal display area	thd	1024			DCLK
HSYNC period time	th	1114	1344	1400	DCLK
HSYNC blanking	thb+thfp	90	320	376	DCLK
Vertical display area	tvd	600			H
VSYNC period time	tv	610	635	800	H
VSYNC blanking	tvb+tvfp	10	35	200	H

7.4 HV mode

HV mode					
Horizontal input timing					
Parameter	Symbol	Value			Unit
Horizontal display area	thd	1024			DCLK
DCLK frequency@ Frame rate=60hz	fclk	Min.	Typ.	Max.	Mhz
		44.9	51.2	63	
1 Horizontal Line	th	1200	1344	1400	DCLK
HSYNC pulse width	thpw	Min.	1		
		Typ.	-		
		Max.	140		
HSYNC back porch	thbp	160	160	160	
HSYNC front porch	thfp	16	160	216	

Vertical input timing					
Parameter	Symbol	Value			Unit
		Min.	Typ.	Max.	
Vertical display area	tvd	600			H
VSYNC period time	tv	624	635	750	H
VSYNC pulse width	tvpw	1	-	20	H
VSYNC back porch	tvb	23	23	23	H
VSYNC front porch	tvfp	1	12	127	H



7.5 Power On/Off Sequence

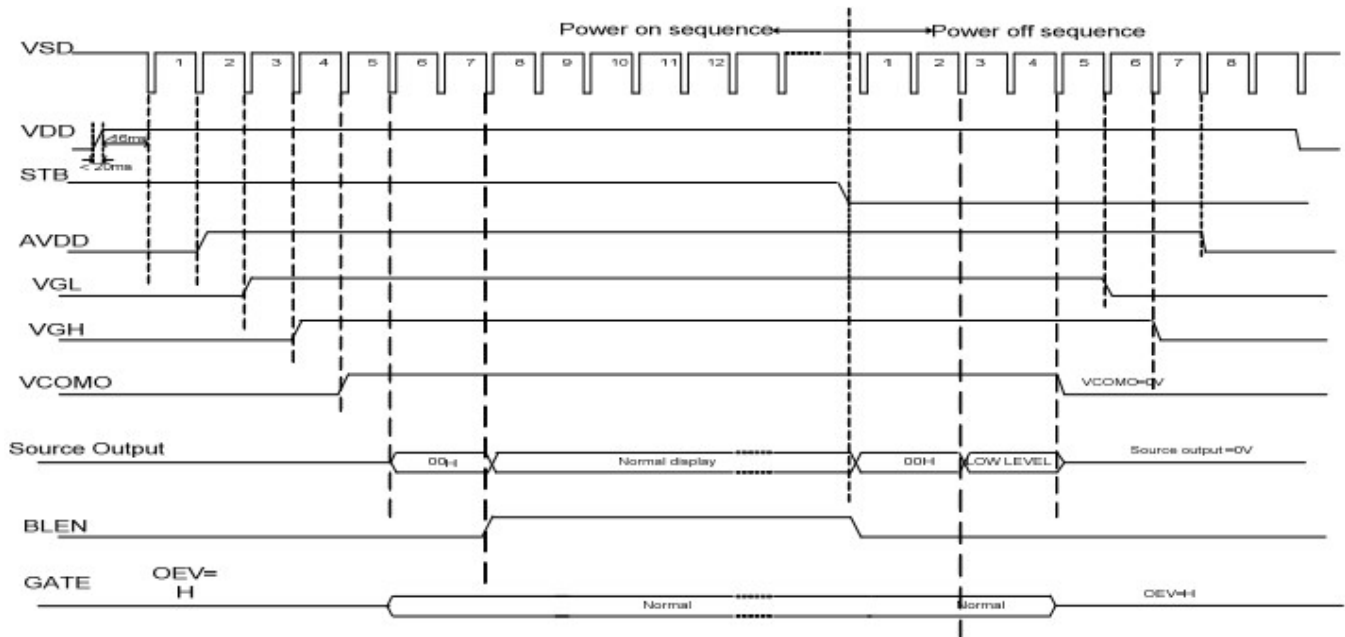

Power On/Off timing chart

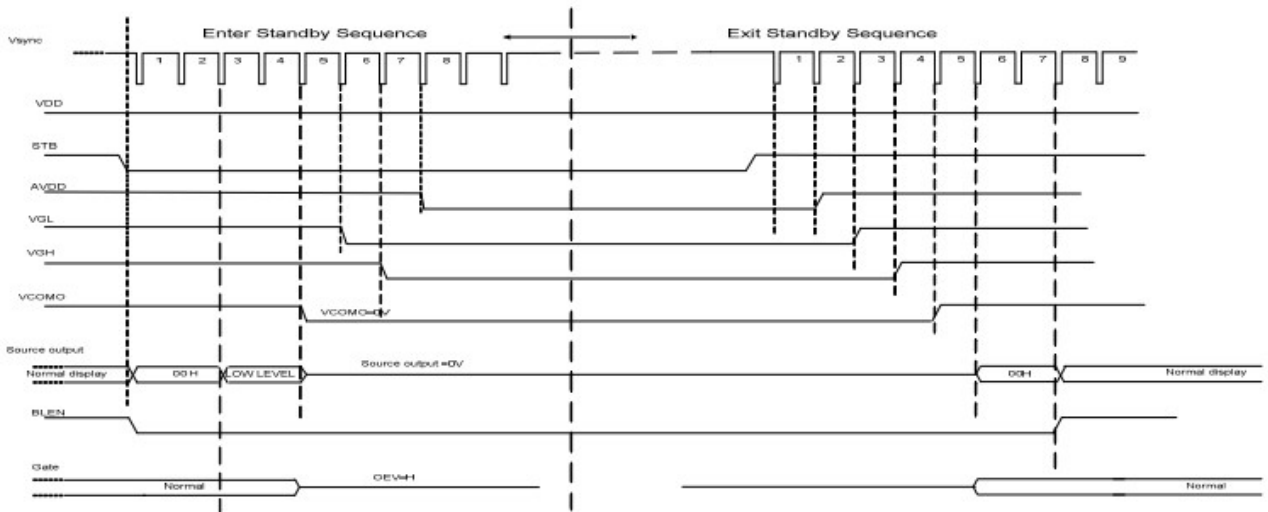

Enter and Exit Standby Mode timing chart

Note: Low level=3Fh, when NBW=L(Normally white)
 Low level=00h, when NBW=H(Normally black)



7.6 Timing

7.6.1 Vertical Timing Diagram HV mode(Cascade)

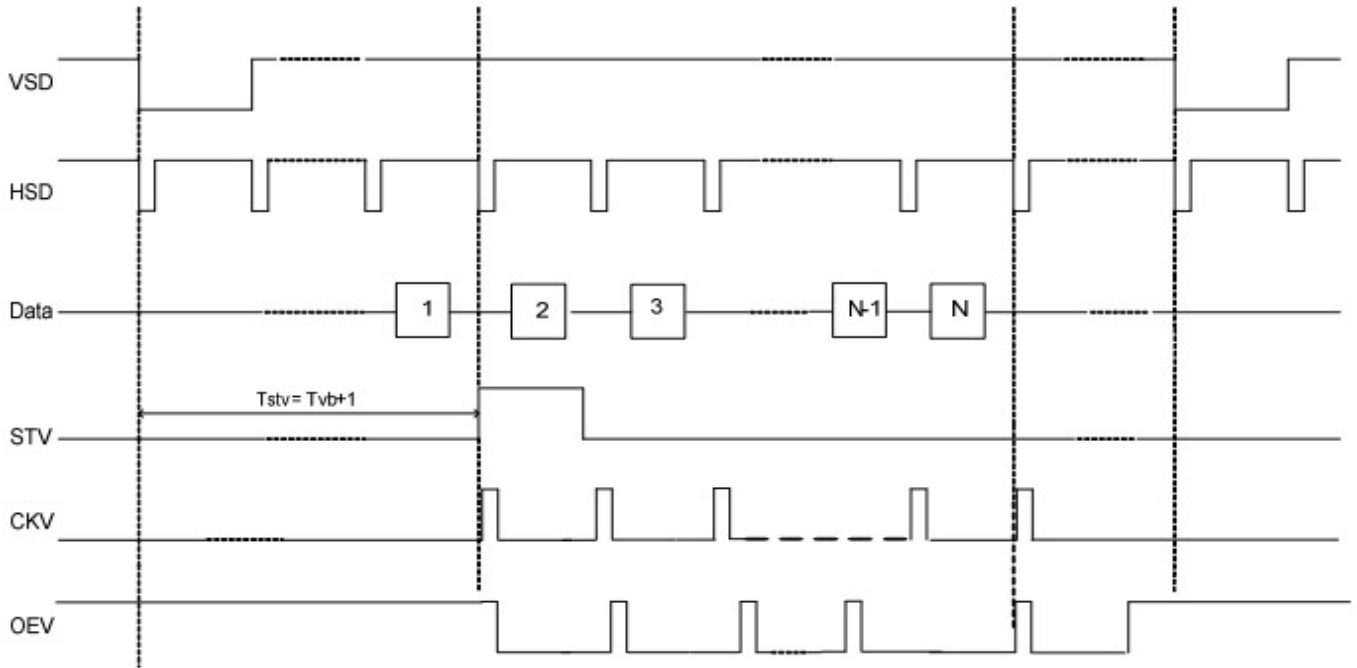

Vertical Timing Diagram HV mode(Cascade)

7.6.2 Vertical Timing Diagram DE mode(Cascade)

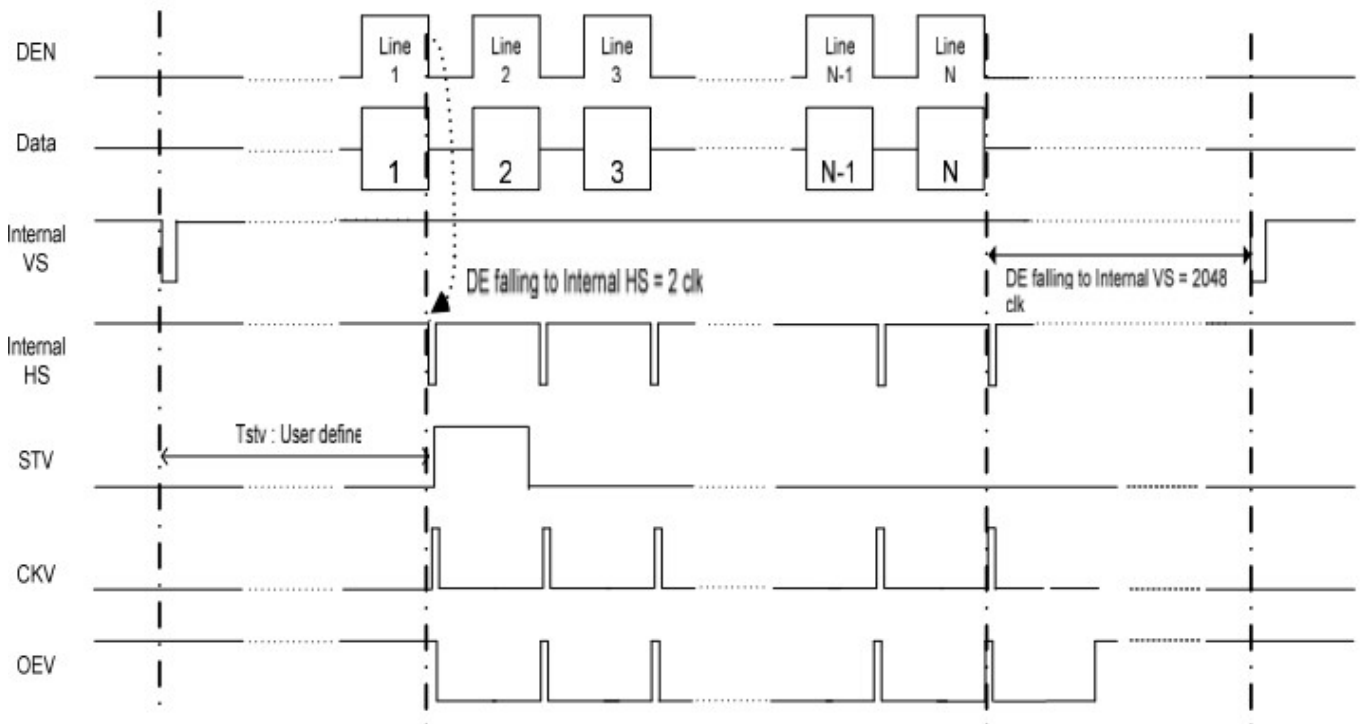

Vertical Timing Diagram DE mode(Cascade)



8. Backlight Characteristic

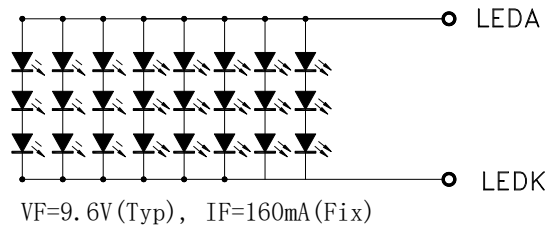

Item	Symbol	MIN	TYP	MAX	UNIT	Test Condition
Supply Voltage	Vf	8.1	9.6	9.9	V	If=160mA
Supply Current	If	-	160	-	mA	-
Luminous Intensity for LCM	-	400	450	-	cd/m ²	If=160mA
Uniformity for LCM	-	80	-	-	%	If=160mA
Life Time	-	-	50000	-	Hr	If=160mA
Backlight Color	White					



9. Optical Characteristics

Item	Conditions	Min.	Typ.	Max.	Unit	Note	
Viewing Angle (CR>10)	Horizontal	θ_L	-	85	-	degree	(1),(2),(6)
		θ_R	-	85	-		
	Vertical	θ_T	-	85	-		
		θ_B	-	85	-		
Contrast Ratio	Center	600	800	-	-	(1),(3),(6)	
Response Time	Rising	-	25	40	ms	(1),(4),(6)	
	Falling						
CF Color Chromaticity (CIE1931)	Red x	Typ. -0.05	0.600	Typ. +0.05	-	(1), (6)	
	Red y		0.340		-		
	Green x		0.364		-		
	Green y		0.578		-		
	Blue x		0.149		-		
	Blue y		0.114		-		
	White x		0.318		-		
	White y		0.356		-		

Note (1) Measurement Setup: The LCD module should be stabilized at given temp. 25°C for 15 minutes to avoid abrupt temperature change during measuring. In order to stabilize the luminance, the measurement should be executed after lighting backlight for 15 minutes in a windless room.

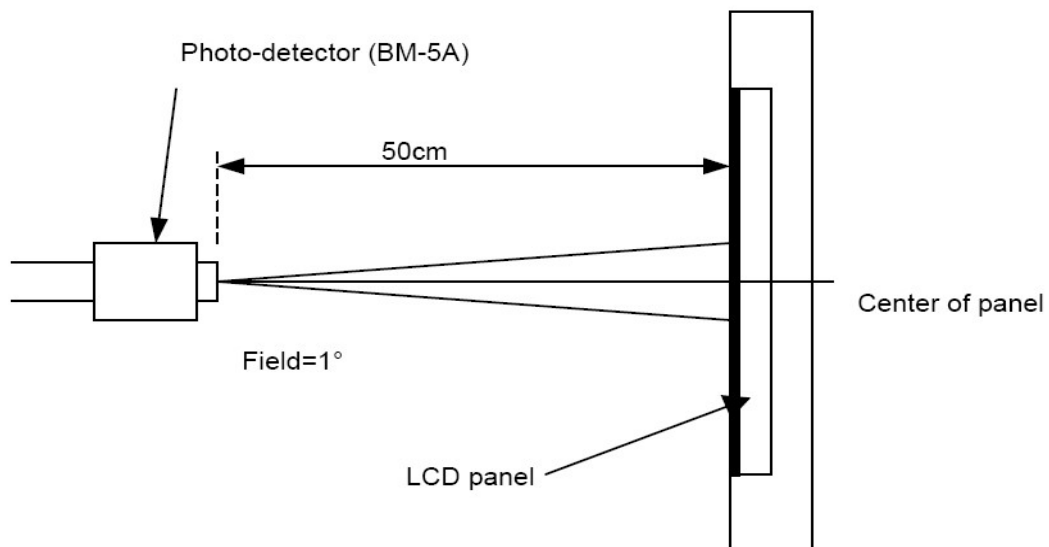



Note (2) Definition of Viewing Angle

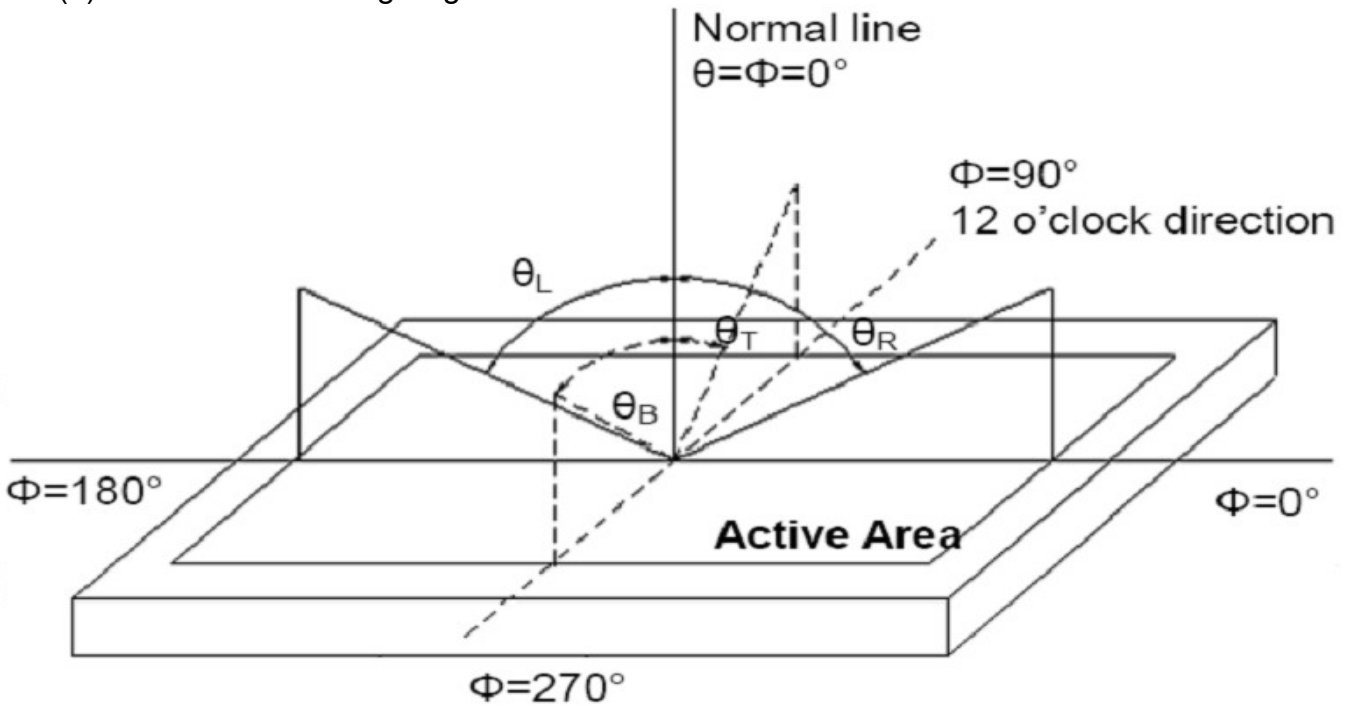

Note (3) Definition of Contrast Ratio (CR)

The contrast ratio can be calculated by the following expression

$$\text{Contrast Ratio (CR)} = L_{63} / L_0$$

L63: Luminance of gray level 63, L0: Luminance of gray level 0

Note (4) Definition of response time

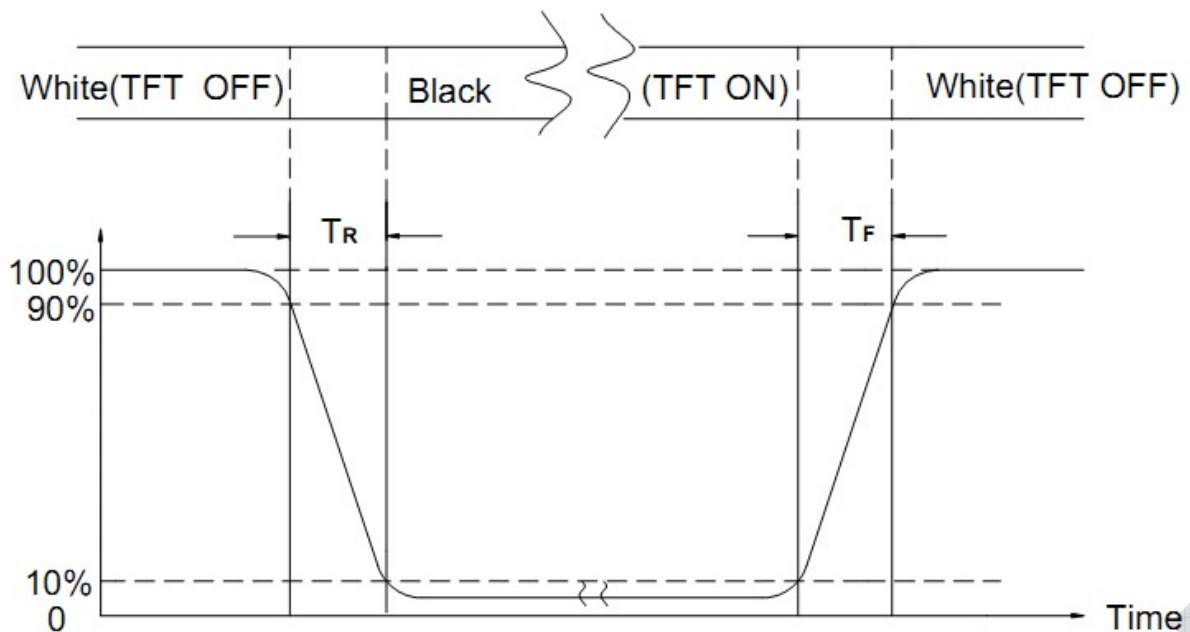

Note (5) Definition of Transmittance (Module is without signal input)

$$\text{Transmittance} = \text{Center Luminance of LCD} / \text{Center Luminance of Back Light} \times 100\%$$

Note (6) Definition of color chromaticity (CIE1931)

Color coordinates measured at the center point of LCD



11. Inspection Standard

11.1. QUALITY :

THE QUALITY OF GOODS SUPPLIED TO PURCHASER SHALL COME UP TO THE FOLLOWING STANDARD.

11.1.1. INSPECTION TOOLS AND INSTRUMENTS

Vernier calipers, film scales, multimeter, magnifying eyepiece, ND5%, luminance meter and so on.

11.1.2. THE METHOD OF PRESERVING GOODS

AFTER DELIVERY OF GOODS FROM KINGTECH TO PURCHASER. PURCHASER SHALL CONTROL THE LCM AT -10 TO 40 ,AND IT MIGHT BE DESIRABLE TO KEEP AT THE NORMAL ROOM TEMPERATURE AND HUMIDITY UNTIL INCOMING INSPECTION OR THROWING INTO PROCESS LINE.

11.1.3. INCOMING INSPECTION

(A) THE METHOD OF INSPECTION

IF PURCHASER MAKE AN INCOMING INSPECTION , A SAMPLING PLAN SHALL BE APPLIED ON THE CONDITION THAT QUALITY OF ONE DELIVERY SHALL BE REGARDED AS ONE LOT.

(B) THE STANDARD OF QUALITY

ISO-2859-1 (SAME AS MIL-STD-105E) ,LEVEL:II

CLASS	AQL(%)
CRITICAL	0.4 %
MAJOR	0.65 %
MINOR	1.5 %

EVERY ITEM SHALL BE INSPECTED ACCORDING TO THE CLASS.

(C) MEASURE

IF AS THE RESULT OF ABOVE RECEIVING INSPECTION , A LOT OUT IS DISCOVERED. PURCHASER SHALL BE INFORM SELLER OF IT WITHIN SEVEN DAYS. BUT FIRST SHIPMENT WITHIN FOURTEEN DAYS.

11.1.4. WARRANTY POLICY

KINGTECH WILL PROVIDE ONE-YEAR WARRANTY FOR THE PRODUCTS ONLY IF UNDER SPECIFICATION OPERATING CONDITIONS. KINGTECH WILL REPLACE NEW PRODUCTS FOR THESE DEFECT PRODUCTS WHICH UNDER WARRANTY PERIOD AND BELONG TO THE RESPONSIBILITY OF KINGTECH.

11.2. CHECKING CONDITION

11.2.1.CHECKING DIRECTION SHALL BE IN THE 45 DEGREE AREA TO FACE THE SAMPLE.

11.2.2.CHECKER SHALL SEE OVER 300±25 mm. WITH BARE EYES FAR FROM SAMPLE

11.2.3.Ambient Illumination:

0 ~30 Lux for functional inspection

500 ~ 1200 Lux for external appearance inspection.

11.2.4. TEST AREA:

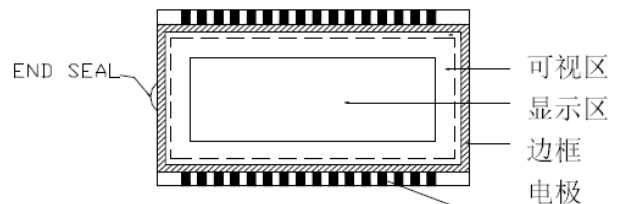

11.2.5. Inspection should be carried out with rope electrostatic ring and static finger cover (both hands except small fingers must be worn)

11.2.6. The inspector may make a visual inspection or a comparative examination with a film



ruler and a magnifying eyepiece. Individual defects shall be determined according to the limited samples.

11.2.7. Functional testing uses electrical testing fixtures or test fixtures required by customers.

11.2.8. the ion fan should be used when testing.

11.2.9. the principle of judgment

11.3.1 If the defect outside the visual area does not affect the assembly and display, it will be judged as a good product.

11.3.2 Poor definition

Pixel:

A combination of three sub-pixels (Red + Green + Blue).

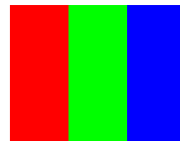

Dot:

Any of the sub-pixels (Red or Green or Blue).

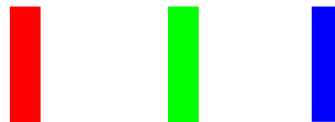

Bright and dark dots:

A point pixel (sub-pixel: R, G, B pixels) is lit or turned off during the display function test.

Highlights:

Usually considered to be shown on a black screen.

Dark spots:

They are generally considered to be shown on R, G, B solid colors or white images.

Neighborhood:

Two or three adjacent point pixels (dot: sub-pixel) connected together (R, G or G, B or B, R or RGB).



11.3. INSPECTION PLAN :

CLASS	ITEM	JUDGEMENT	CLASS
PACKING & INDICATE	1. OUTSIDE AND INSIDE PACKAGE	"MODEL NO." , "LOT NO." AND "QUANTITY" SHOULD INDICATE ON THE PACKAGE.	Minor
	2. MODEL MIXED AND QUANTITY	OTHER MODEL MIXED.....REJECTED QUANTITY SHORT OR OVER.....REJECTED	Critical
	3. PRODUCT INDICATION	"MODEL NO." SHOULD INDICATE ON THE PRODUCT	Major
ASSEMBLY	4. DIMENSION, LCD GLASS SCRATCH AND SCRIBE DEFECT.	ACCORDING TO SPECIFICATION OR DRAWING.	Major
APPEARANCE	5. VIEWING AREA	POLARIZER EDGE OR LCD'S SEALING LINE IS VISABLE IN THE VIEWING AREAREJECTED	Minor
	6. BLEMISH · BLACK SPOT · WHITE SPOT IN THE LCD AND LCD GLASS CRACKS	ACCORDING TO STANDARD OF VISUAL INSPECTION(INSIDE VIEWING AREA)	Minor
	7. BLEMISH · BLACK SPOT · WHITE SPOT AND SCRATCH ON THE POLARIZER	ACCORDING TO STANDARD OF VISUAL INSPECTION(INSIDE VIEWING AREA)	Minor
	8. BUBBLE IN POLARIZER	ACCORDING TO STANDARD OF VISUAL INSPECTION(INSIDE VIEWING AREA)	Minor
	9. LCD'S RAINBOW COLOR	STRONG DEVIATION COLOR (OR NEWTON RING) OF LCD.....REJECTED. OR ACCORDING TO LIMITED SAMPLE (IF NEEDED, AND INSIDE VIEWING AREA)	Minor
ELECTRICAL	10. ELECTRICAL AND OPTICAL CHARACTERISTICS (CONTRAST· VOP · CHROMATICITY ... ETC)	ACCORDING TO SPECIFICATION OR DRAWING . (INSIDE VIEWING AREA)	Critical
	11.MISSING LINE	MISSING DOT · LINE · CHARACTERREJECTED	Critical
	12.SHORT CIRCUIT· WRONG PATTERN DISPLAY	NO DISPLAY · WRONG PATTERN DISPLAY · CURRENT CONSUMPTION OUT OF SPECIFICATION..... REJECTED	Critical
	13. DOT DEFECT (FOR COLOR AND TFT)	ACCORDING TO STANDARD OF VISUAL INSPECTION	Minor

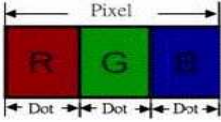

NO.	CLASS	ITEM	JUDGEMENT										
11. 4. 1	MINOR	BLACK AND WHITE SPOT FOREIGN MATERIEL DUST IN THE CELL BLEMISH SCRATCH	(A) ROUND TYPE: unit: mm <table border="1" style="width:100%"> <thead> <tr> <th>DIAMETER (mm.)</th> <th>ACCEPTABLE Q'TY</th> </tr> </thead> <tbody> <tr> <td>$\varnothing \leq 0.2$</td> <td>Distances $\geq 1mm$</td> </tr> <tr> <td>$0.2 < \varnothing \leq 0.3$</td> <td>3 (Distance $\geq 5mm$)</td> </tr> <tr> <td>$0.3 < \varnothing \leq 0.4$</td> <td>2 (Distance $\geq 5mm$)</td> </tr> <tr> <td>$0.4 < \varnothing$</td> <td>0</td> </tr> </tbody> </table> <p style="text-align:center">NOTE: $\varnothing = (LENGTH * WIDTH) / 2$</p>	DIAMETER (mm.)	ACCEPTABLE Q'TY	$\varnothing \leq 0.2$	Distances $\geq 1mm$	$0.2 < \varnothing \leq 0.3$	3 (Distance $\geq 5mm$)	$0.3 < \varnothing \leq 0.4$	2 (Distance $\geq 5mm$)	$0.4 < \varnothing$	0
			DIAMETER (mm.)	ACCEPTABLE Q'TY									
$\varnothing \leq 0.2$	Distances $\geq 1mm$												
$0.2 < \varnothing \leq 0.3$	3 (Distance $\geq 5mm$)												
$0.3 < \varnothing \leq 0.4$	2 (Distance $\geq 5mm$)												
$0.4 < \varnothing$	0												
(S) LINE TYPE: unit: mm <table border="1" style="width:100%"> <thead> <tr> <th>LENG</th> <th>WIDTH</th> <th>ACCEPTABLE QTY</th> </tr> </thead> <tbody> <tr> <td>.....</td> <td>$W \leq 0.03$</td> <td>Distance $\geq 1mm$</td> </tr> <tr> <td>L</td> <td>$0.03 < W \leq 0.05$</td> <td>3 (Distanced $\geq 15mm$)</td> </tr> <tr> <td>.....</td> <td>$0.05 < W$</td> <td>FOLLOW ROUND TYPE</td> </tr> </tbody> </table> <p style="text-align:center">NOTE: $\varnothing = (LENGTH * WIDTH) / 2$</p>	LENG	WIDTH	ACCEPTABLE QTY	$W \leq 0.03$	Distance $\geq 1mm$	L	$0.03 < W \leq 0.05$	3 (Distanced $\geq 15mm$)	$0.05 < W$	FOLLOW ROUND TYPE	
LENG	WIDTH	ACCEPTABLE QTY											
.....	$W \leq 0.03$	Distance $\geq 1mm$											
L	$0.03 < W \leq 0.05$	3 (Distanced $\geq 15mm$)											
.....	$0.05 < W$	FOLLOW ROUND TYPE											
11. 4. 2	MINOR	BUBBLE IN POLARIZER DENT ON POLARIZER	unit: mm. <table border="1" style="width:100%"> <thead> <tr> <th>DIAMETER</th> <th>ACCEPTABLE Q' TY</th> </tr> </thead> <tbody> <tr> <td>$\varnothing < 0.2$</td> <td>Distance $\geq 1mm$</td> </tr> <tr> <td>$0.2 < \varnothing \leq 0.3$</td> <td>4 (Distance $\geq 15mm$)</td> </tr> <tr> <td>$0.3 < \varnothing \leq 0.4$</td> <td>3 (Distance $\geq 15mm$)</td> </tr> <tr> <td>$0.4 < \varnothing$</td> <td>0</td> </tr> </tbody> </table>	DIAMETER	ACCEPTABLE Q' TY	$\varnothing < 0.2$	Distance $\geq 1mm$	$0.2 < \varnothing \leq 0.3$	4 (Distance $\geq 15mm$)	$0.3 < \varnothing \leq 0.4$	3 (Distance $\geq 15mm$)	$0.4 < \varnothing$	0
DIAMETER	ACCEPTABLE Q' TY												
$\varnothing < 0.2$	Distance $\geq 1mm$												
$0.2 < \varnothing \leq 0.3$	4 (Distance $\geq 15mm$)												
$0.3 < \varnothing \leq 0.4$	3 (Distance $\geq 15mm$)												
$0.4 < \varnothing$	0												
11. 4. 3	MINOR	Dot Defect	<table border="1" style="width:100%"> <thead> <tr> <th>Items</th> <th>ACC. Q' TY</th> </tr> </thead> <tbody> <tr> <td>Bright dot</td> <td>$N \leq 1$ (Distance $\geq 15mm$)</td> </tr> <tr> <td>Dark dot</td> <td>$N \leq 3$ (Distance $\geq 15mm$)</td> </tr> </tbody> </table> <p>Pixel Define :</p>  <p>Note</p> <ol style="list-style-type: none"> The definition of dot: The size of a defective dot over 1 of whole dot is regarded as one defective dot. Definition: $< 1/2$ dot and visible by 5% ND filter Bright dot: Dots appear bright and unchanged in size m which LCD panel is displaying under black pattern. Dark dot: Dots appear dark and unchanged in size in which LCD panel is displaying under pure red, green , blue pattern. 	Items	ACC. Q' TY	Bright dot	$N \leq 1$ (Distance $\geq 15mm$)	Dark dot	$N \leq 3$ (Distance $\geq 15mm$)				
Items	ACC. Q' TY												
Bright dot	$N \leq 1$ (Distance $\geq 15mm$)												
Dark dot	$N \leq 3$ (Distance $\geq 15mm$)												
11. 4. 4	MINOR	Mura	Not visible through 5% ND filter in 50% gray or judge by limit sample if necessary										

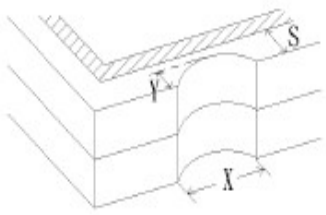
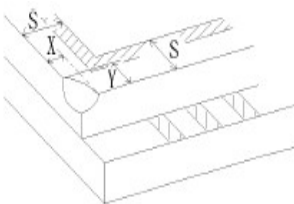
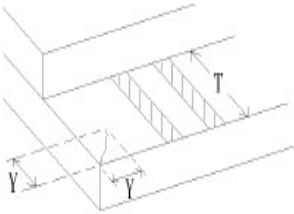
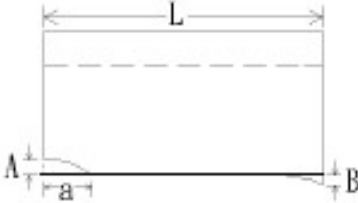
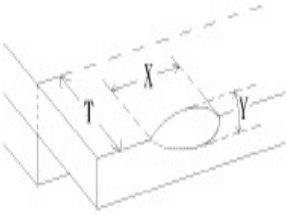
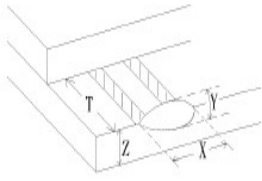
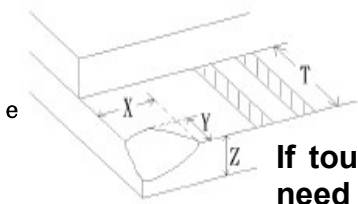

NO.	CLASS	ITEM	JUDGEMENT
11.4.5	MINOR	LCD GLASS CHIPPING	 <p>X ≥ 3mm Y > S</p> <p>Reject</p>
11.4.6	MINOR	LCD GLASS CHIPPING	 <p>X OR Y > S</p> <p>Reject</p>
11.4.7	MINOR	LCD GLASS CRACK	 <p>Continuous burst NG</p> <p>Reject</p>
11.4.8	MINOR	LCD GLASS SCRIBE DEFECT	 <p>According to dimension</p>
11.4.9	MINOR	LCD GLASS CHIPPING (on the terminal area)	 <p>Y < 1/2Z Y ≥ 0.5mm X ≥ 3mm</p> <p>Reject</p>
11.4.10	MINOR	LCD GLASS CHIPPING (on the terminal surface)	 <p>Y < 1/2Z Y ≥ 0.5mm X ≥ 3mm</p> <p>Reject</p>
11.4.11	MINOR	LCD GLASS CHIPPING	 <p>X ≥ 3mm Y > T</p> <p>If touch the electrode lines the need to retain the two-thirds electrode lines</p> <p>R</p>



12. Handling Precautions

12.1 Mounting method

The LCD panel of KINGTECH TFT module consists of two thin glass plates with polarizers which easily be damaged. And since the module is so constructed as to be fixed by utilizing fitting holes in the printed circuit board.

Extreme care should be needed when handling the LCD modules.

12.2 Caution of LCD handling and cleaning

When cleaning the display surface, Use soft cloth with solvent

[Recommended below] and wipe lightly

- Isopropyl alcohol
- Ethyl alcohol

Do not wipe the display surface with dry or hard materials that will damage the polarizer surface.

Do not use the following solvent:

- Water
- Aromatics

Do not wipe ITO pad area with the dry or hard materials that will damage the ITO patterns

Do not use the following solvent on the pad or prevent it from being contaminated:

- Soldering flux
- Chlorine (Cl) , Sulfur (S)

If goods were sent without being silicon coated on the pad, ITO patterns could be damaged due to the corrosion as time goes on.

If ITO corrosion happens by miss-handling or using some materials such as Chlorine (Cl), Sulfur (S) from customer, Responsibility is on customer.

12.3 Caution against static charge

The LCD module uses C-MOS LSI drivers, so we recommend that you:

Connect any unused input terminal to POWER or GROUND, do not input any signals before power is turned on, and ground your body, work/assembly areas, and assembly equipment to protect against static electricity.

12.4 packing

- Module employs LCD elements and must be treated as such.
- Avoid intense shock and falls from a height.
- To prevent modules from degradation, do not operate or store them exposed direct to sunshine or high temperature/humidity

12.5 Caution for operation

- It is an indispensable condition to drive LCD's within the specified voltage limit since the higher voltage than the limit causes the shorter LCD life.
- An electrochemical reaction due to direct current causes LCD's undesirable deterioration, so that the use of direct current drive should be avoided.
- Response time will be extremely delayed at lower temperature than the operating temperature range and on the other hand at higher temperature LCD's show dark color in them. However those phenomena do not mean malfunction or out of order with LCD's, which will come back in the specified operation temperature.
- If the display area is pushed hard during operation, some font will be abnormally displayed but it resumes normal condition after turning off once.
- Slight dew depositing on terminals is a cause for electro-chemical reaction resulting in terminal open circuit.



Usage under the maximum operating temperature, 50%Rh or less is required.

12.6 storing

In the case of storing for a long period of time for instance, for years for the purpose or replacement use, the following ways are recommended.

- Storage in a polyethylene bag with the opening sealed so as not to enter fresh air outside in it. And with no desiccant.
- Placing in a dark place where neither exposure to direct sunlight nor light's keeping the storage temperature range.
- Storing with no touch on polarizer surface by the anything else.

[It is recommended to store them as they have been contained in the inner container at the time of delivery from us

12.7 Safety

- It is recommendable to crash damaged or unnecessary LCD's into pieces and wash off liquid crystal by either of solvents such as acetone and ethanol, which should be burned up later.
- When any liquid leaked out of a damaged glass cell comes in contact with your hands, please wash it off well with soap and water

13. Precaution for Use

13.1

A limit sample should be provided by the both parties on an occasion when the both parties agreed its necessity. Judgment by a limit sample shall take effect after the limit sample has been established and confirmed by the both parties.

13.2

On the following occasions, the handing of problem should be decided through discussion and agreement between responsible of the both parties.

- When a question is arisen in this specification
- When a new problem is arisen which is not specified in this specifications
- When an inspection specifications change or operating condition change in customer is reported to KINGTECH TFT , and some problem is arisen in this specification due to the change
- When a new problem is arisen at the customer's operating set for sample evaluation in the customer site.

14. Packing Method

TBD