



PRODUCT SPECIFICATIONS

For Customer: _____

: APPROVAL FOR SPECIFICATION

Customer Model No. PV07081D0150F-CT

: APPROVAL FOR SAMPLE

Module No.: _____

Date : 2023.10.10

Table of Contents

No.	Item	Page
1	Cover Sheet(Table of Contents)	P1
2	Revision Record	P2
3	General Specifications	P3-P4
4	Outline Drawing	P5
5	Absolute Maximum Ratings	P6
6	Electrical Specifications	P7-P13
7	Optical Characteristics	P14-P17
8	Reliability Test Items and Criteria	P18
9	Precautions for Use of LCD Modules	P19-P20

For Customer's Acceptance:

Approved By	Comment

PREPARED	CHECKED	APPROVER



3. General Specifications

PV07081D0150F-CT is a TFT-LCD module. It is composed of a TFT-LCD panel, driver IC, FPC, a back light unit and CTP. The 7.0" display area contains 800x480 pixels and can display up to 16.7M colors. This product accords with RoHS environmental criterion.

3.1 LCD Parameter

Item	Contents	Unit	Note
LCD Type	TFT	-	
Display color	16.7M		
Viewing Direction	ALL	O'Clock	
Operating temperature	-20~+70	°C	
Storage temperature	-30~+80	°C	
Module size	Refer to outline drawing	mm	
Active Area(W×H)	153.84X85.63	mm	
Number of Dots	800x480	dots	
Driver IC	EK73002&EK9716	-	
Power Supply Voltage	3.3	V	
Outline Dimensions	Refer to outline drawing	-	
Backlight	6S1P-LEDs (white)	pcs	
Interface	RGB24bits	-	



3.2 CTP Parameter

Item	Contents	Unit	Note
Outline Size	165(H)X100(V)X0.7(T)	mm	
Cover View Area	154.54(H)X86.33(V)		
CTP Resolution	EK73002&EK9716	dots	
Interface Mode	IIC	-	
Touch Mode	10 Human fingers multi-touch	-	
Surface hardness	$\geq 7H$	-	
Transparency	$\geq 85\%$	-	
Accuracy	Entre +/-1.5mm,Edge +/-2.5mm	mm	
CTP Controller	ILI2130	-	
Power Supply Voltage	3.3	V	



4.Outline.Drawing

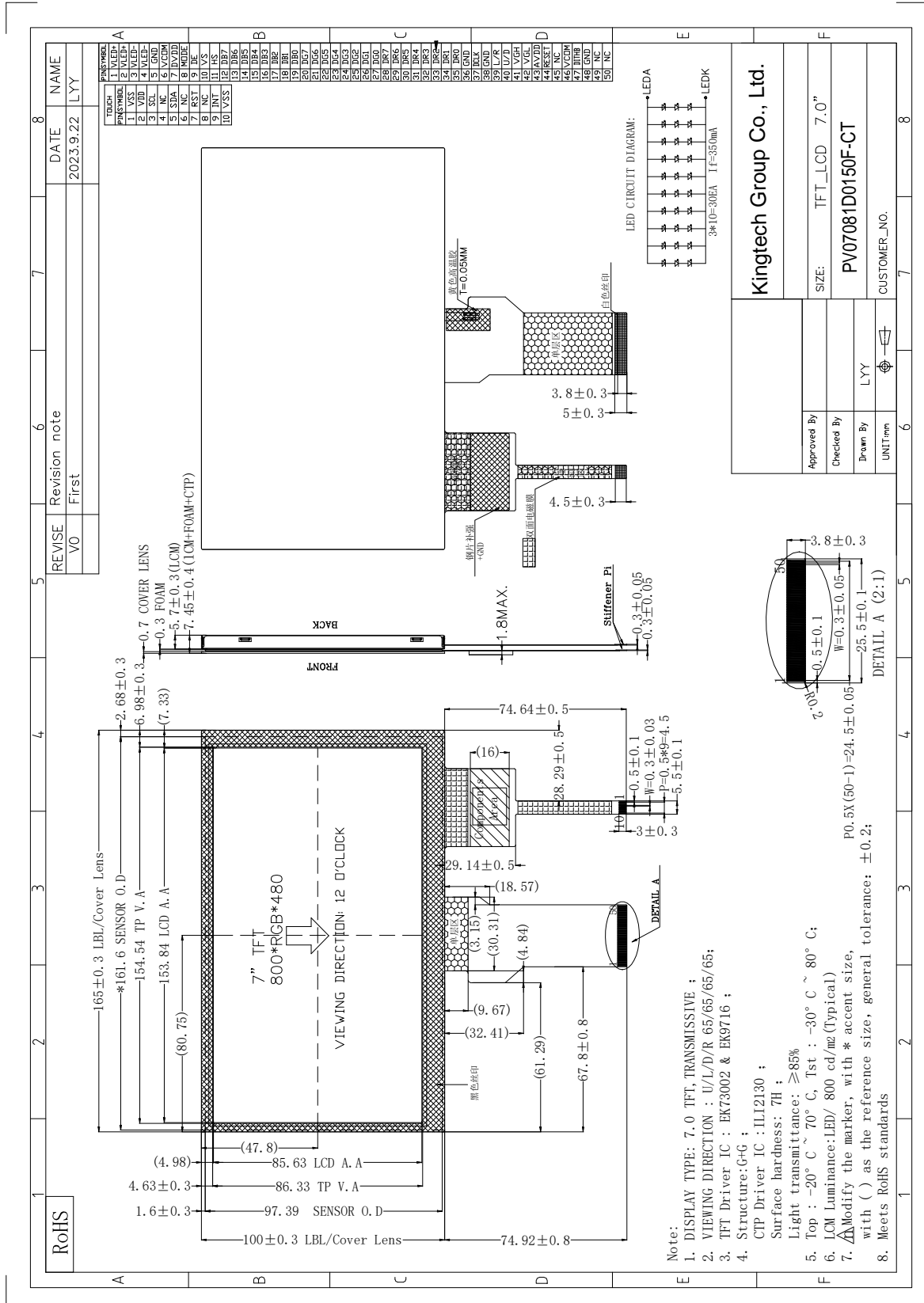



5. Absolute Maximum Ratings(Ta=25 °C)

5.1 Electrical Absolute Maximum Ratings.(Vss=0V ,Ta=25 °C)

Item	Symbol	Min.	Max.	Unit	Note
Power Supply Voltage	V _{DD}	-0.3	5	V	1, 2
CTP Power Supply Voltage	VDD	2.8	3.3	V	1, 2

Notes:

1. If the module is above these absolute maximum ratings. It may become permanently damaged. Using the module within the following electrical characteristic conditions are also exceeded, the module will malfunction and cause poor reliability.
2. V_{DD} > V_{SS} must be maintained.
3. Please be sure users are grounded when handing LCD Module.

5.2 Environmental Absolute Maximum Ratings.

Item	Storage		Operating	
	MIN.	MAX.	MIN.	MAX.
Ambient Temperature	-30°C	80°C	-20°C	70°C
Humidity	-	-	-	-

1. The response time will become lower when operated at low temperature.
2. Background color changes slightly depending on ambient temperature.
The phenomenon is reversible.
3. Ta<=40 °C:85%RH MAX.
Ta>=40 °C:Absolute humidity must be lower than the humidity of 85%RH at 40 °C.



6. Electrical Specifications and Instruction Code

6.1 Electrical characteristics(V_{SS}=0V ,T_a=25 °C)

Parameter	Symbol	Condition	Min	Typ	Max	Unit	Note
Power supply	VDD	T _a =25°C	2.7	3.3	3.6	V	
Input voltage	'H'	V _{IH}	V _{DD} =3.3V	0.7V _{DD}	-	V _{DD}	V
	'L'	V _{IL}	V _{DD} =3.3V	0	-	0.3V _{DD}	V

Note: If one of the above items is exceeded its maximum limitation momentarily, the quality of the product may be degraded. Absolute maximum limitation, therefore, specify the values exceeding which the product may be physically damaged. Be sure to use the product within the recommend range.

6.2 LED backlight specification(V_{SS}=0V ,T_a=25 °C)

Item	Symbol	Condition	Min	Typ	Max	Unit	Note
Supply voltage VLED	V _f	I _f =350mA	8.4	9	9.9	V	
Uniformity	Δ Bp	I _f =350mA	75	-	-	%	
LED Life Time	-	-	20000	-	-	hr	1

Note 1: Brightness to be decreased to 50% of the initial value at ambient temperature T_A=25 °C



6.3 Interface signals

6.3.1 LCM PIN

Pin No.	Symbol	I/O	Function
1-2	VLED+	P	LED back light(Anode)
3-4	VLED-	P	LED back light(Cathode)
5	GND	P	Ground
6	VCOM	I	Common voltage for panel
7	DVDD	P	Power supply
8	MODE	I	DE/SYNC mode select. Normally pull high. MODE="1": DE mode. (Default) MODE="0": HSD/VSD mode.
9	DE	I	Data enable signal
10	VS	I	Vertical synchronizing signal
11	HS	I	Line synchronizing signal
12-19	DB7-DB0	I	Blue data bus
20-27	DG7-DG0	I	Green data bus
28-35	DR7-DR0	I	Red data bus
36	GND	P	Ground
37	DCLK	I	Dot clock signal
38	GND	P	Ground
39	L/R	I	Select left to right scanning direction
40	U/D	I	Select up or down scanning direction
41	VGH	P	Positive power for TFT
42	VGL	P	Negative power for TFT
43	AVDD	P	Input positive power from system/ external power IC.
44	RESET	I	Global reset signal input pin
45	NC	I	No connection
46	VCOM	I	Common voltage for panel
47	DITHB	I	Dithering control pin.
48	GND	P	Ground
49-50	NC		No connection



CTP interface

Pin No.	Symbol	I/O	Function
1	VSS	P	Ground.
2	VDD	P	Power supply
3	SCL	I	Serial interface clock
4	NC		No connection
5	SDA	I	Serial input/output data bus
6	NC		No connection
7	RST	I	Reset signal
8	NC		No connection
9	INT	I	External Interrupt pin
10	VSS	P	Ground.



6.4 Power Sequence

When power on: VCC → VGL → VGH

When power off: VGH → VGL → VCC

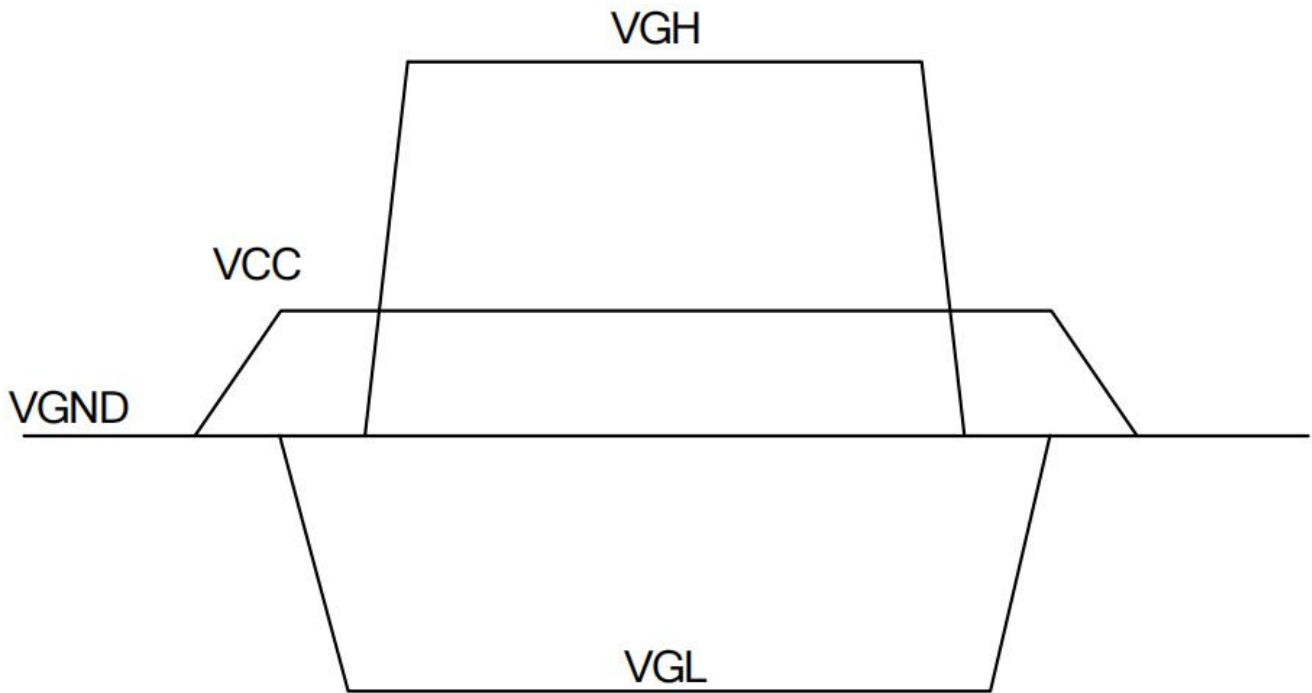



DC Characteristic (VGH = 25V, VGL = -15V, VCC = 3.3V, VGND = 0V, Ta = 25°C)

Parameter	Symbol	Condition	Rating			Unit	Application pin
			Min.	Typ.	Max.		
Input H voltage	V _{IH}	-	0.7VCC	-	VCC	V	All input
Input L voltage	V _{IL}	-	0	-	0.3VCC	V	All input
Output H voltage	V _{OH}	I _{OH} =200μA	VCC-0.3	-	VCC	V	STVU,D
Output L voltage	V _{OL}	I _{OL} =200μA	0	-	0.3	V	STVU,D
Output H resistance	R _{OH}	V _X = VGH -0.5V	-	-	1000	Ω	OUT[1] ~ OUT[960]
Output L resistance	R _{OL}	V _X = VGL+0.5V	-	-	1000	Ω	OUT[1] ~ OUT[960]
Input leakage current	I _{IN}	-	-1.0	-	+1.0	μA	Note ⁽²⁾
Pull high / low resistance	R _{PHL}	V _{IN} =GND V _{IN} =VCC	70	200	400	kΩ	XON, SEL, ,MODE
VGH Power consumption	I _{VGH}	Note ⁽¹⁾	-	-	200	μA	-
VGL Power consumption	I _{VGH}	Note ⁽¹⁾	-	-	-200	μA	-
VCC Power consumption	I _{VCC}	Note ⁽¹⁾	-	-	150	μA	-

Note 1: Power consumption with the following condition: Output no load, VGH=25V, VGL=-15V, VCC=3.3V, V_{IH} =VCC, V_{IL}=VGND, F_{CKV} = 60 KHz, OE = V_{IL}, XON= V_{IH}.

Note 2: All input except XON, SEL, MODE



6.6 AC Characteristics

AC Characteristics (VGH = 25V, VGL = -15V, VCC = 3.3V, GND = 0V, Ta = 25°C)

Parameter	Symbol	Condition	Rating			Unit
			Min.	Typ.	Max.	
CKV period	t _{CKV}	-	5	-	-	μs
CKV pulse width	t _{CKVH} , t _{CKVL}	50% duty cycle	2.5	-	-	μs
OE pulse width	t _{WOE}	-	1	-	-	μs
XON pulse width	t _{WXAO}	-	10	-	-	μs
Data setup time	t _{SU}	-	0.2	-	-	μs
Data hold time	t _{HD}	-	0.3	-	-	μs
CKV to output delay time	t _{PD1}	CL=200pF	-	-	0.9	μs
Start pulse output delay time	t _{PD2}	CL=20pF	-	-	0.5	μs
OE to output delay time	t _{PD3}	CL=200pF	-	-	0.9	μs
XON to output delay time	t _{PD4}	CL=200pF	-	-	50	μs

Note 1: The measurement point for all of above signals is at 50% of input/output amplitude.



6.7 Timing Waveform

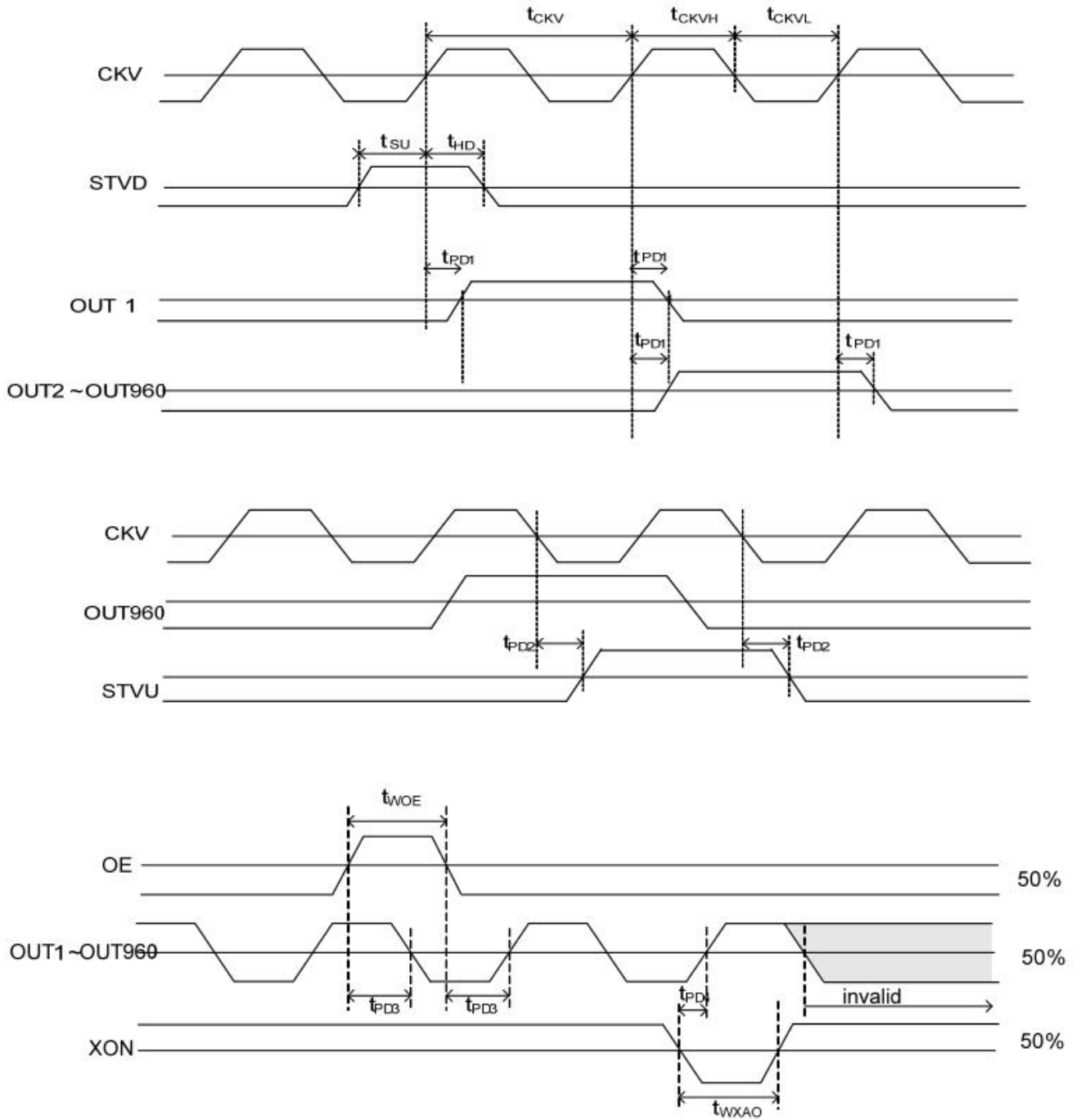



7. Optical Characteristics

Item	Symbol	Condition	Min.	Typ.	Max.	Unit	Note	
Brightness	Bp	$\theta=0^\circ$	-	800	-	cd/m ²	1	
Uniformity	ΔBp	$\Phi=0^\circ$	75	-	-	%	1,2	
Viewing Angle	3:00	Cr \geq 10	-	65	-	Deg	3	
	6:00		-	65	-			
	9:00		-	65	-			
	12:00		-	65	-			
Contrast Ratio	Cr	$\theta=0^\circ$ $\Phi=0^\circ$	-	500	-	-	4	
Color of CIE Coordinate	W	x	$\theta=0^\circ$ $\Phi=0^\circ$	Typ-0 .05	TBD	Typ+0. 05	-	1,6
		y					-	
	R	x					-	
		y					-	
	G	x					-	
		y					-	
	B	x					-	
		y					-	
NTSC Ratio	S		-	50	-	%		

Note: The parameter is slightly changed by temperature, driving voltage and materiel

Note 1: The data are measured after LEDs are turned on for 5 minutes. LCM displays full white. The brightness is the average value of 9 measured spots. Measurement equipment BM-7 (Φ 5mm)

Measuring condition:

- Measuring surroundings: Dark room.
- Measuring temperature: Ta=25 °C.
- Adjust operating voltage to get optimum contrast at the center of the display.

Measured value at the center point of LCD panel after more than 5 minutes while backlight turning on.

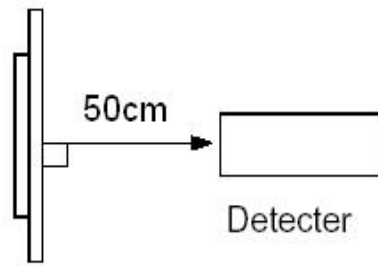

Note 2: The luminance uniformity is calculated by using following formula.

$$\Delta Bp = Bp (\text{Min.}) / Bp (\text{Max.}) \times 100 (\%)$$

$Bp (\text{Max.})$ = Maximum brightness in 9 measured spots

$Bp (\text{Min.})$ = Minimum brightness in 9 measured spots.

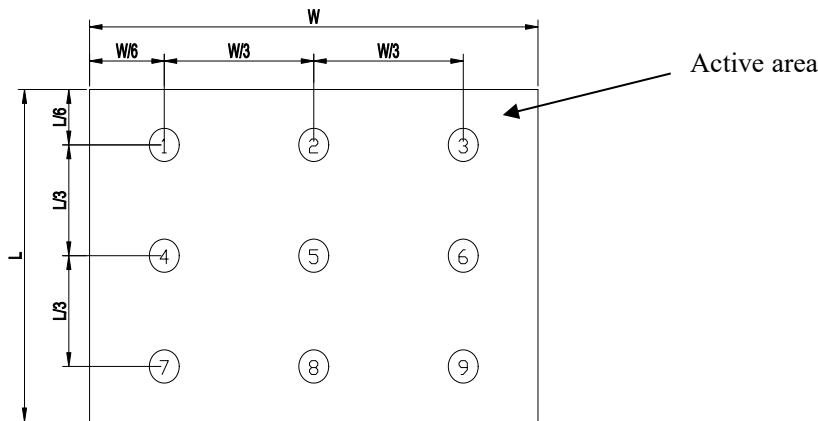

Note 3: The definition of viewing angle:

Refer to the graph below marked by ϑ and ϕ

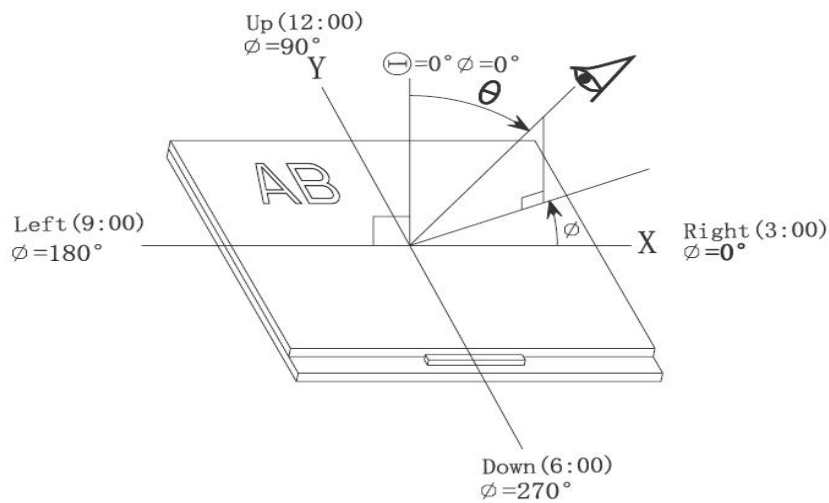

Note 4: Definition of contrast ratio.(Test LCD using DMS501)

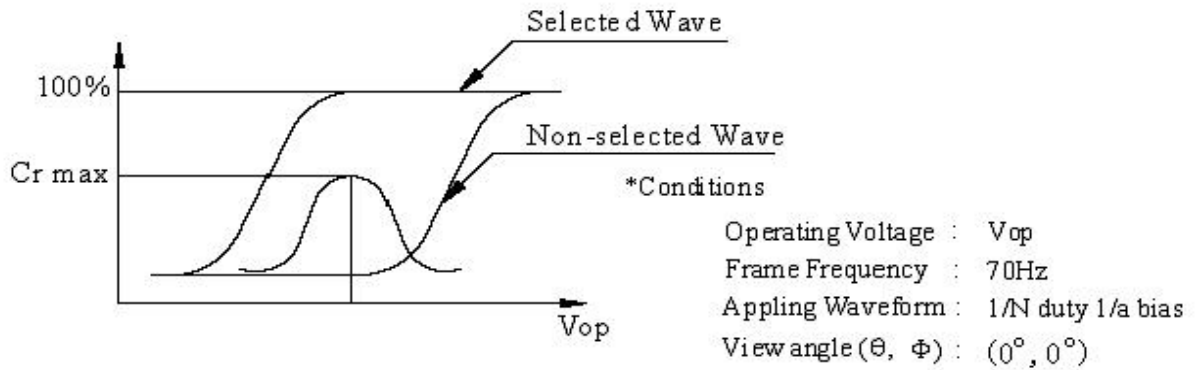

$$\text{Contrast ratio}(Cr) = \frac{\text{Brightness of selected dots}}{\text{Brightness of non-selected dots}}$$

Note 5: Definition of Response time. (Test LCD using DMS501):

The output signals of photo detector are measured when the input signals are changed from "black" to "white"(falling time) and from "white" to "black"(rising time), respectively. The response time is defined as the time interval between the 10% and 90% of amplitudes. Refer to figure as below.

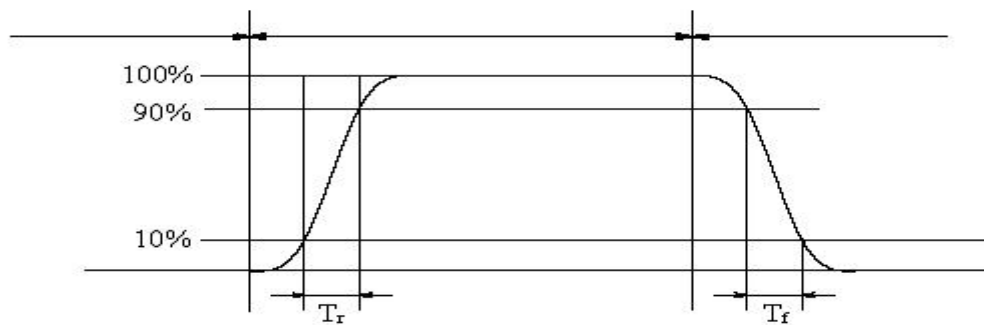

The definition of response time

Note 6: Definition of Color of CIE Coordinate and NTSC Ratio.

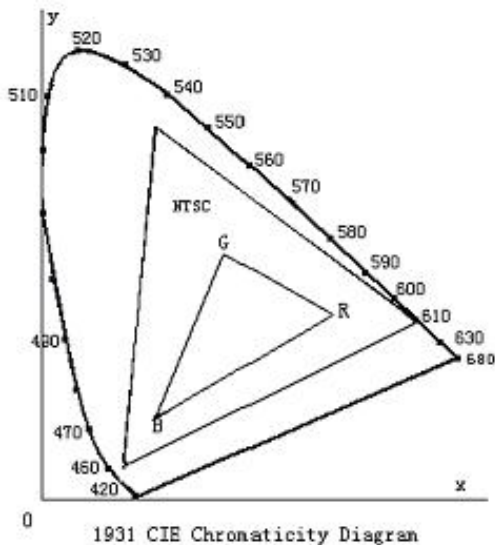

Color gamut:

$$S = \frac{\text{area of RGB triangle}}{\text{area of NTSC triangle}} \times 100\%$$

Note 7: Definition of cross talk.



*Cross talk ratio(%)=|pattern A Brightness-pattern B Brightness|/pattern A Brightness*100*

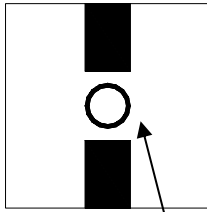

Pattern A

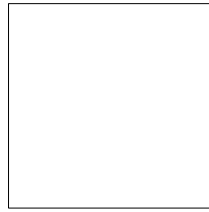

Pattern B

Measurement point(center)

Electric volume value=3F+/-3Hex



8. Reliability Test Items and Criteria

No	Test Item	Test condition	Criterion
1	High Temperature Storage	80°C±2°C 96H Restore 2H at 25°C Power off	1. After testing, cosmetic and electrical defects should not happen. 2. Total current consumption should not be more than twice of initial value.
2	Low Temperature Storage	-30°C±2°C 96H Restore 2H at 25°C Power off	
3	High Temperature Operation	70°C±2°C 96H Restore 2H at 25°C Power on	
4	Low Temperature Operation	-20°C±2°C 96H Restore 4H at 25°C Power on	
5	High Temperature/Humidity Operation	60°C±2°C 90%RH 96H Power on	
6	Temperature Cycle	-30°C → 80°C 30min 5min 30min after 5 cycle, Restore 2H at 25°C Power off	

Note: Operation: Supply 3.3V for logic system.

The inspection terms after reliability test, as below

ITEM	Inspection
Contrast	CR>50%
IDD	IDD<200%
Brightness	Brightness>60%
Color Tone	Color Tone+/-0,05



9. Precautions for Use of LCD Modules

9.1 Handling Precautions

9.1.1 The display panel is made of glass. Do not subject it to a mechanical shock by dropping it from a high place, etc.

9.1.2 If the display panel is damaged and the liquid crystal substance inside it leaks out, be sure not to get any in your mouth, if the substance comes into contact with your skin or clothes, promptly wash it off using soap and water.

9.1.3 Do not apply excessive force to the display surface or the adjoining areas since this may cause the color tone to vary.

9.1.4 The polarizer covering the display surface of the LCD module is soft and easily scratched. Handle this polarizer carefully.

9.1.5 If the display surface is contaminated, breathe on the surface and gently wipe it with a soft dry cloth. If still not completely clear, moisten cloth with one of the following solvents:

— Isopropyl alcohol — Ethyl alcohol

Solvents other than those mentioned above may damage the polarizer. Especially, do not use the following:

— Water — Ketone — Aromatic solvents

9.1.6 Do not attempt to disassemble the LCD Module.

9.1.7 If the logic circuit power is off, do not apply the input signals.

9.1.8 To prevent destruction of the elements by static electricity, be careful to maintain an optimum work environment.

a. Be sure to ground the body when handling the LCD Modules.

b. Tools required for assembly, such as soldering irons, must be properly ground.

c. To reduce the amount of static electricity generated, do not conduct assembly and other work under dry conditions.

d. The LCD Module is coated with a film to protect the display surface. Be care when peeling off this protective film since static electricity may be generated.



9.2 Storage precautions

9.2.1 *When storing the LCD modules, avoid exposure to direct sunlight or to the light of fluorescent lamps.*

9.2.2 *The LCD modules should be stored under the storage temperature range. If the LCD modules will be stored for a long time, the recommend condition is:*

Temperature : 0 °C ~ 40 °C

Relatively humidity: ≤80%

9.2.3 *The LCD modules should be stored in the room without acid, alkali and harmful gas.*

9.3 *The LCD modules should be no falling and violent shocking during transportation, and also should avoid excessive press, water, damp and sunshine.*